

# AMISCO

**CONTRACT FURNITURE**  
**MOBILIER COMMERCIAL**

Collection  
2019/2020

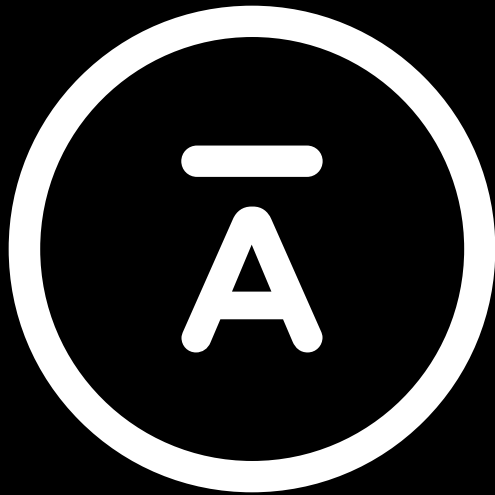



# Contents Table des matières

About Amisco / À propos d'Amisco .....	<b>28</b>
Product Specifications / Spécifications de produits .....	<b>33</b>
Industrial Index / Index industriel .....	<b>34</b>
Contemporary Index / Index contemporain .....	<b>42</b>
Transitional Index / Index transitionnel .....	<b>53</b>
Chairs & Stools / Chaises & tabourets .....	<b>57</b>
Accent Furniture / Meubles d'accent .....	<b>176</b>
Lounge Chairs / Fauteuils d'accent .....	<b>188</b>
Table Bases / Bases de table .....	<b>191</b>
Regular Tabletop Program / Programme de dessus de table réguliers .....	<b>222</b>
Custom Tabletop Program / Programme de dessus de table sur mesure .....	<b>226</b>
Beds / Lits .....	<b>230</b>
5 Year Limited Warranty / Garantie limitée de 5 ans .....	<b>248</b>
Metal Colors / Couleurs de métal .....	<b>249</b>
Wood Colors / Couleurs de bois .....	<b>251</b>
Coverings / Recouvrements .....	<b>253</b>
Numerical Index / Index numérique .....	<b>254</b>
Alphabetical Index / Index alphabétique .....	<b>270</b>



**Dexter 30223-CO DSDB**

Chair / Chaise

**Dexter 40323-30CO DSDB**

Non swivel stool / Tabouret non pivotant

**Norcross 50563-CO**

Table base / Base de table





**Norcross** 50563-42CO

Table base / Base de table

90410

Distressed solid wood tabletop / Dessus de table en bois massif usé





**Weston 40534-CO USUB**

Swivel stool / *Tabouret pivotant*

**Weston 30534-CO USUB**

Swivel chair / *Chaise pivotante*

**Alys 50570-CO**

Table base / *Base de table*







**Easton 41535-26CO USUB**

Swivel stool / *Tabouret pivotant*

**Easton 30535-CO USUB**

Chair / *Chaise*







**Brock** 47635-CO USUB

Pedestal swivel stool / *Tabouret piédestal pivotant*

**Singapore** 30435-CO USUB

Accent chair / *Fauteuil d'accent*







**Washington** 30303-CO USMB

Chair / Chaise

**Kai** 50609-CO

Table base / Base de table

**Washington** 40303-CO USMB

Non swivel stool / Tabouret non pivotant

**Billy** 50551-42CO

Table base / Base de table





**Pablo** 35304-CO USUB

Chair / Chaise



**Alberto** 40112-CO DSMB

Non swivel stool / *Tabouret non pivotant*







## **Architect** 40263-CO DSDB

Screw stool / *Tabouret à vis*

## **Norcross** 50563-CO

Table base / *Base de table*

90408

Distressed solid wood tabletop - 36" x 36"  
*Dessus de table en bois massif usé de 36" x 36"*





**Architect** 30263-CO DSDB

Chair / Chaise

**Upright** 30410-CO DSNB

Bench / Banc

**Parade** 50565-CO

Table base / Base de table

90484

Distressed solid wood tabletop - 40" x 84" with decorative bolts  
Dessus de table en bois massif usé de 40" x 84" avec vis décoratives

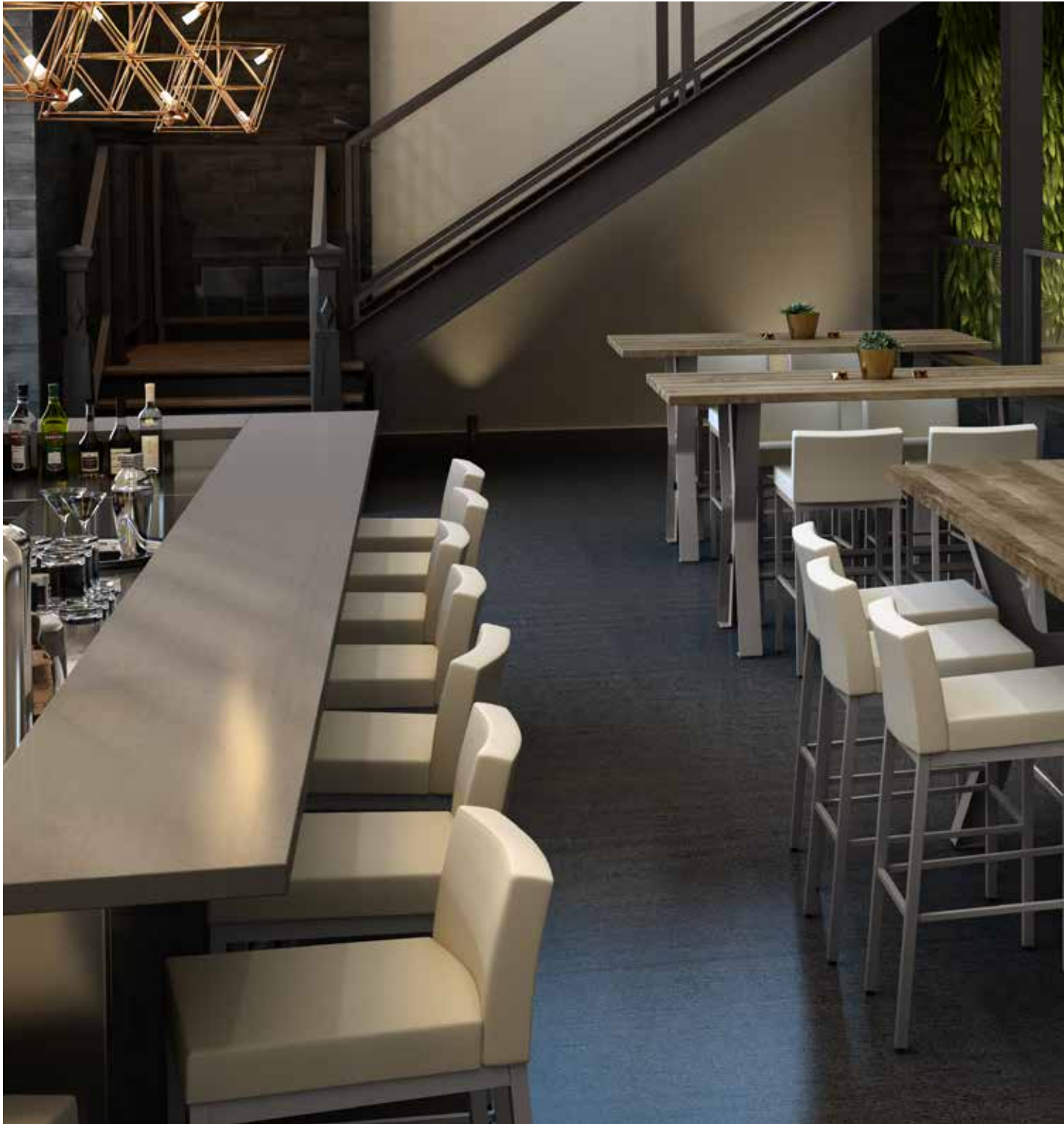

**Perry** 35312-CO USUB

Chair / Chaise

**Fairfield** 45314-30CO USUB

Non swivel stool / Tabouret non pivotant





## Parade 50565-42CO

Table base (bar height) / Base de table (hauteur bar)

90485

Distressed solid wood tabletop - 40" x 84"  
Dessus de table en bois massif usé de 40" x 84"

## Parade 50566-CO

Table base (table height) / Base de table (hauteur table)

90487

Distressed solid wood tabletop - 40" x 72"  
Dessus de table en bois massif usé de 40" x 72"



**Grissom** 30560-CO USUB

Chair / Chaise

**Grissom** 41560-30CO USUB

Swivel stool / Tabouret pivotant

**Singapore** 30435-CO USUB

Lounge chair / Fauteuil d'accent





**Nicholson 50667-CO**

Table base (table height) / Base de table (hauteur table)

**Nicholson 50667-42CO**

Table base (bar height) / Base de table (hauteur bar)

93485

Solid wood tabletop (ash) - 40" x 84"  
Dessus de table en bois massif (frêne) de 40" x 84"



**Upright** 40264-30CO USDB

Non swivel stool / *Tabouret non pivotant*

**Norcross** 50563-42CO

Table base / *Base de table*

90408

Distressed solid wood tabletop - 36" x 36"  
*Dessus de table en bois massif usé de 36" x 36"*









**Angelina** 30227-CO DSDB

Chair / Chaise

**Angelina** 40227-26CO DSDB

Non swivel stool / Tabouret non pivotant

**Bridget** 30575-CO USUB

Chair / Chaise

**Salton** 50500-CO

Table base (table height) / Base de table (hauteur table)



## **Salton** 50500-36CO

Table base (counter height) / *Base de table (hauteur comptoir)*

## 90408-CO

Distressed solid wood tabletop - 36" x 36"  
*Dessus de table en bois massif usé de 36" x 36"*

## 90409-CO

Distressed solid wood tabletop - 52" dia.  
*Dessus de table en bois massif usé de 52" dia.*

## 90410-CO

Distressed solid wood tabletop - 36" x 60"  
*Dessus de table en bois massif usé de 36" x 60"*





**Darcy** 30574-CO USUB

Chair / Chaise

**Darlene** 40573-26CO USUB

Non swivel stool / Tabouret non pivotant





## **Carbon 50662-CO**

Table base (table height) / *Base de table (hauteur table)*

## **Carbon 50662-36CO**

Table base (counter height) / *Base de table (hauteur comptoir)*



**Corey** 34560-CO USUB

Chair / Chaise

**Pablo** 35304-CO USUB

Chair / Chaise

**Bailey** 49307-26CO USUB

Non swivel stool / Tabouret non pivotant





## **Bennington** 50660-CO

Table base (table height) / *Base de table (hauteur table)*

## **93487-CO**

Solid wood tabletop - 40" x 72"  
*Dessus de table en bois massif de 40" x 72"*

## **Carbon** 50662-CO

Table base (table height) / *Base de table (hauteur table)*

## **93408-CO**

Solid wood tabletop - 36" x 36"  
*Dessus de table en bois massif de 36" x 36"*

# About Amisco / À propos d'Amisco

## Our Pride: Products 100% North American Made

- Made to order products
- Finishes and coverings customization
- Superior North American Steel
- Constant investment on equipments at the cutting edge of technology
- Competitive lead time
- Products delivered assembled

## Notre fierté: une production 100% nord-américaine

- Produits fabriqués sur commande
- Personnalisation des finis et recouvrements
- Acier nord-américain de qualité supérieure
- Investissements constants sur des équipements à la fine pointe de la technologie
- Courts délais de production
- Produits livrés assemblés



## Our Commitment: Quality in Every Product We Make

- Sturdy and durable construction
- Products built to meet the industry's stringent requirements
- Full length welds on the entire main structure
- Electrostatic powder coat for a scratch resistant metal finish

## Notre promesse: la qualité de fabrication dans chacun de nos produits

- Construction robuste et durable
- Produits rencontrant les exigences les plus strictes de l'industrie
- Soudures pleine longueur sur la structure
- Finition du métal avec une poudre électrostatique pour une couleur résistante aux égratignures





## **Our Signature: Unique Designs and Exceptional Comfort**

- Original designs by American and Canadian designers
- On trend products
- Specific attention to product ergonomomy

## ***Notre signature: des designs uniques au confort inégalé***

- *Designs originaux par des designers canadiens et américains*
- *Produits suivant les dernières tendances*
- *Attention particulière à l'ergonomie des produits*



# Amisco: A Family Business since 1954

At the time of its foundation in 1954, Amisco was already dedicated to the institutional market as its main field of business was school furnishings made of steel tube. Quickly, the company added woodworking and upholstery to its expertise. Over time, Amisco diversified its product offer to serve hospitality clients, and kept providing furniture for the institutional market.

Amisco designs and produces furniture in its two factories located in Québec, Canada. The main one is specialized in steel transformation, and the second manufactures upholstered and wood components.

For over two decades, the third generation of the Poitras family leads the business. Réjean Poitras is President and Chief Executive Officer, and his older brother, Claude Poitras, is Vice President of Finance. Their entrepreneurial spirit is still very strong and their passion for the furniture industry is far from fading!

Now over 60 years old, Amisco takes great pride in providing contract grade furniture to diversified clients as the US Army, Holiday Inn, Windham, Best Western, Comfort Inn, and many restaurants of all sizes.

## *Amisco: une histoire de famille depuis 1954*

*Entreprise familiale fondée en 1954, Amisco se spécialisait dans la production de mobilier scolaire et institutionnel en tube de métal. Rapidement, elle a ajouté le travail du bois et le rembourrage à ses champs d'expertise. Au fil du temps, Amisco a diversifié son offre afin de répondre aux besoins de mobilier de l'industrie de la restauration et de l'hôtellerie, en plus de continuer à servir ses clients institutionnels.*

*Amisco conçoit et fabrique ses produits à partir de ses deux usines situées au Québec; une étant spécialisée dans la transformation de l'acier, et l'autre dans la confection de composantes de rembourrage et de bois.*

*Depuis maintenant deux décennies, la troisième génération de la famille Poitras est aux commandes de l'organisation. Réjean Poitras est président et chef de la direction, et Claude Poitras, son frère aîné, est vice-président aux finances. La flamme entrepreneuriale est toujours bien présente et leur passion pour l'industrie n'est pas près de s'éteindre!*

*60 ans après sa fondation, Amisco est fière de servir des clients variés tels que l'armée américaine, les chaînes d'hôtels Holiday Inn, Windham, Best Western, Comfort Inn, ainsi que plusieurs restaurants de toutes envergures.*





**Réjean Poitras**

President and Chief Executive Officer  
*Président et chef de la direction*

**Claude Poitras**

Vice President, Finance  
*Vice-président, Finances*



## Ecodesign: A Second Nature for Amisco

At Amisco, incorporating environmental considerations into product design and taking our eco-impact into account are more than just talk.

**Lifecycle** – Our products stand out for durability and can be given a new lease on life by repainting the steel or recovering the seats.

**Waste reduction** – We have reduced our packaging to a minimum and recycle all our production scraps.

**Reduced resource use** – From steel to paint, our products are made using mostly recycled and recyclable materials.

**Reduced energy consumption** – We have put in place a number of energy efficiency initiatives.

Our manufacturing processes are environmentally friendly.

## L'éco-conception: une seconde nature pour Amisco

*Chez Amisco, l'intégration des aspects environnementaux dans la conception de nos produits et la prise en compte de notre impact sur l'environnement n'en restent pas seulement au discours.*

**Cycle de vie** – Nos produits se démarquent par leur durabilité, et il est possible de leur donner une deuxième vie en repeignant l'acier ou en recouvrant à nouveau les sièges.

**Réduction des déchets** – Nos emballages ont été réduits à leur minimum et tous nos rebuts de production sont recyclés.

**Diminution de la consommation des ressources** – En matière d'acier comme de peinture, nos produits sont fabriqués à partir de matériaux majoritairement recyclés et recyclables.

**Diminution de la consommation d'énergie** – Nous avons mis sur pied plusieurs projets qui visent à réduire notre consommation d'énergie.

*Nos procédés de fabrication sont respectueux de l'environnement.*

## Eco Amisco





# Product Specifications

## Spécifications de produits

### Suffix Glossary / Définition des suffixes

<b>DSDB</b>	Distressed wood seat - Distressed wood backrest <i>Siège en bois massif usé - Dossier en bois massif usé</i>	<b>USMB</b>	Upholstered seat - Metal backrest <i>Siège rembourré - Dossier en métal</i>
<b>DSMB</b>	Distressed wood seat - Metal backrest <i>Siège en bois massif usé - Dossier en métal</i>	<b>USNB</b>	Upholstered seat - No backrest <i>Siège rembourré - Sans dossier</i>
<b>DSNB</b>	Distressed wood seat - No backrest <i>Siège en bois massif usé - Sans dossier</i>	<b>USUB</b>	Upholstered seat - Upholstered backrest <i>Siège rembourré - Dossier rembourré</i>
<b>USDB</b>	Upholstered seat - Distressed wood backrest <i>Siège rembourré - Dossier en bois massif usé</i>	<b>USWB</b>	Upholstered seat - Wood backrest <i>Siège rembourré - Dossier en bois</i>

### Measurement Glossary / Glossaire des mesures

**W/L** (width), **D/P** (depth), **H** (height), **S** (seat height), **A** (arms height), **F** (footboard height), **COM S** (COM seat), **COM BR** (COM backrest), **COM A** (COM armrest), **W/P** (product weight).

The «—» symbol indicates that the color photographed is no longer available or that the dimension is not applicable.

**W/L** (largeur), **D/P** (profondeur), **H** (hauteur), **S** (hauteur du siège), **A** (hauteur des appuis-bras), **F** (hauteur du pied), **COM S** (COM du siège), **COM BR** (COM du dossier), **COM A** (COM des appuis-bras), **W/P** (poids).

Le symbole «—» indique que la couleur photographiée n'est plus disponible ou que la mesure ne s'applique pas.

### Swivel Stools / Tabourets pivotants

All our swivel stools can be ordered:

- as pedestal stool with round plate
- as a bolt down pedestal stool
- with memory return
- without memory return

Please contact Amisco for pricing.

*Tous nos modèles de tabourets pivotants peuvent être commandés:*

- en version piédestal avec plaque ronde
- en version piédestal vissé au plancher
- avec mécanisme à mémoire
- sans mécanisme à mémoire

*Veillez contacter Amisco pour une soumission.*

### Stool Height / Hauteur des tabourets

If the counter is the same height as a kitchen sink, you need 24" or 26" stools.  
If the counter is bar height, you need 30" stools.

*Si le comptoir est de la même hauteur qu'un évier de cuisine, vous avez besoin de tabourets 24" ou 26". Si le comptoir est de la hauteur d'un bar, vous avez besoin de tabourets 30".*

### Strength / Résistance

Chairs & Stools <i>Chaises &amp; tabourets</i>	Load Test <i>Test de charge</i>
Seat / <i>Siège</i>	450 lb
Armrests / <i>Appuis-bras</i>	200 lb
Footrest / <i>Appui-pied</i>	200 lb
Backrest / <i>Dossier</i>	100 lb

Many chairs and stools exceed these loads

*Plusieurs chaises et tabourets peuvent tolérer davantage de charge*

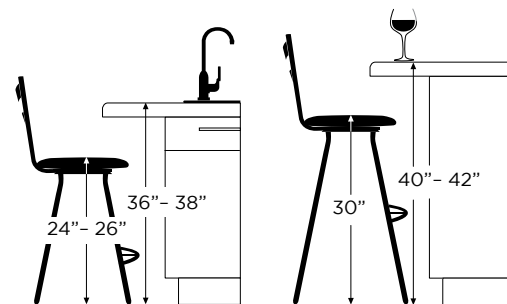

### Bolt Down Pedestal Stool Tabouret piédestal vissé au plancher

Bolt down pedestal stools must be anchored to the floor with appropriate hardware. Amisco is not responsible for any damage caused to the floor or floor covering, or any injury caused by improper anchoring to the floor. Where allowed under the law, AMISCO disclaims liability for all special, incidental and consequential damage.

Fixing screws are not included.

*Les tabourets piédestaux vissés au plancher doivent être fixés au sol avec de la quincaillerie appropriée. Amisco n'est pas responsable de tout dommage occasionné au plancher ou au revêtement de plancher, ni de blessure occasionnée par un ancrage incorrect au sol. Lorsque permis en vertu de la loi, AMISCO renonce à toute responsabilité pour tout dommage direct ou indirect, incident ou conséquent.*

*Les vis de fixations ne sont pas incluses.*

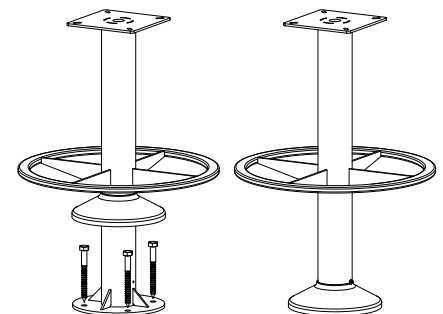



**ALBERTO** 40112-CO DSMB  
P. 12, 59



**ARCHITECT** 30263-CO DSDB  
P. 15, 65



**ARCHITECT** 30263-CO USDB  
P. 65



**ARCHITECT** 30563-CO DSMB  
P. 65



**ARCHITECT** 30563-CO USMB  
P. 65



**ARCHITECT** 40263-CO DSDB  
P. 14, 66



**ARCHITECT** 40263-CO USDB  
P. 66



**ARCHITECT** 40563-CO DSMB  
P. 66



**ARCHITECT** 40563-CO USMB  
P. 66



**ARCHITECT** 42563-CO DSNB  
P. 67



**ARCHITECT** 42563-CO USNB  
P. 67



**BEAN** 39268-CO DSDB  
P. 70



**BEAN** 39268-CO USDB  
P. 70



**BEAN** 39568-CO DSMB  
P. 70



**BEAN** 39568-CO USMB  
P. 70



**BEAN** 41268-CO DSDB  
P. 71





**BEAN 41268-CO USDB**  
P. 71



**BEAN 41568-CO DSMB**  
P. 71



**BEAN 41568-CO USMB**  
P. 71



**BRADLEY 40038-CO DSNB**  
P. 73



**BRIXTON 30536-CO USUB**  
P. 75



**BRIXTON 41536-CO USUB**  
P. 75



**BUTTON 42460-CO DSNB**  
P. 80



**CENTURY 41549-CO DSMB**  
P. 82



**CENTURY 41549-CO USMB**  
P. 82



**CLUB 39667-CO DSMB**  
P. 84



**CLUB 39667-CO USMB**  
P. 84



**CLUB 41667-CO DSMB**  
P. 84



**CLUB 41667-CO USMB**  
P. 84



**CONNOR 42493-CO DSNB**  
P. 86



**CRESCENT 39123-CO DSMB**  
P. 88



**CRESCENT 49123-CO DSMB**  
P. 88



**DEXTER 30223-CO DSDB**  
P. 2, 94



**DEXTER 30223-CO USDB**  
P. 94



**DEXTER 40323-CO DSDB**  
P. 2, 94



**DEXTER 40323-CO USDB**  
P. 94



**EDWIN 35198-CO DSMB**  
P. 97



**EDWIN 41498-CO DSMB**  
P. 98



**EDWIN 49198-CO DSMB**  
P. 98



**ELWOOD 50165-CO**  
P. 186



**ELWOOD 50265-CO**  
P. 186



**ELWOOD 50365-CO**  
P. 186



**ELWOOD 50465-CO**  
P. 185



**ELWOOD 50765-CO**  
P. 185



**GATLIN 40491-CO DSMB**  
P. 106



**GATLIN 40491-CO USMB**  
P. 106



**GRACE 42414-CO DSNB**  
P. 107



**GUSTAVSON 44661-CO DSDB**  
P. 109





**GUSTAVSON 44661-CO USDB**  
P. 109



**JETSON 41527-CO DSMB**  
P. 115



**JETSON 41527-CO USMB**  
P. 115



**JETSON 41567-CO DSDB**  
P. 116



**JETSON 41567-CO USDB**  
P. 116



**KENT 41528-CO DSMB**  
P. 118



**KENT 41528-CO USMB**  
P. 118



**KYLE 35214-CO DSDB**  
P. 120



**KYLE 41414-CO DSDB**  
P. 122



**KYLE 49224-CO DSDB**  
P. 123



**LAREDO 52553-CO**  
P. 205



**LAUREN 30593-CO DSMB**  
P. 125



**LAUREN 30593-CO USMB**  
P. 125



**LAUREN 40593-CO DSMB**  
P. 125



**LAUREN 40593-CO USMB**  
P. 125



**NORCROSS 50563-CO**  
P. 2, 14, 212



**NORCROSS** 50563-36/42CO  
P. 2, 20, 212



**OWEN** 39154-CO DSMB  
P. 137



**PARADE** 50565-CO  
P. 15, 213



**PARADE** 50566-CO  
P. 16, 214



**PARADE** 50565-36/42CO  
P. 16, 213



**PARADE** 50566-36/42CO  
P. 18, 214



**RALLY** 31661-CO DSDB  
P. 148



**RALLY** 31661-CO USDB  
P. 148



**RALLY** 40661-CO DSDB  
P. 148



**RALLY** 40661-CO USDB  
P. 148



**RENDER** 41543-CO DSMB  
P. 150



**RUPERT** 21145-CO  
P. 187



**RUPERT** 51145-CO  
P. 187



**RUSSELL** 41526-CO USUB  
P. 153



**RYAN** 40034-CO DSNB  
P. 154



**SCROLLER** 41624-CO DSMB  
P. 155





**SCROLLER** 41624-CO USMB  
P. 155



**SIERRA** 52554-CO  
P. 219



**SIERRA** 52556-CO  
P. 219



**SNYDER** 30529-CO DSDB  
P. 157



**SNYDER** 30529-CO USDB  
P. 157



**SNYDER** 41529-CO DSDB  
P. 157



**SNYDER** 41529-CO USDB  
P. 157



**SOUTHCROSS** 50562-CO  
P. 220



**SOUTHCROSS** 50567-CO  
P. 220



**SWICE** 42444-CO DSNB  
P. 161



**SYMMETRY** 31669-CO DSDB  
P. 162



**SYMMETRY** 31669-CO USDB  
P. 162



**SYMMETRY** 41669-CO DSDB  
P. 162



**SYMMETRY** 41669-CO USDB  
P. 162



**TORI** 39124-CO DSMB  
P. 163



**TORI** 39144-CO DSMB  
P. 163



**TURBO 41493-CO DSMB**  
P. 166



**UNITY 39663-CO DSDB**  
P. 167



**UNITY 41663-CO USDB**  
P. 167



**UNITY 41666-CO DSMB**  
P. 167



**UNITY 41666-CO USMB**  
P. 167



**UPLIFT 40614-CO DSMB**  
P. 168



**UPLIFT 40614-CO USMB**  
P. 168



**UPLIFT 42614-CO DSNB**  
P. 168



**UPLIFT 42614-CO USNB**  
P. 168



**UPRIGHT 30408-CO DSNB**  
P. 178



**UPRIGHT 30408-CO USNB**  
P. 178



**UPRIGHT 30410-CO DSNB**  
P. 15, 178



**UPRIGHT 30410-CO USNB**  
P. 178



**UPRIGHT 40264-CO DSDB**  
P. 169





**UPRIGHT 40264-CO USDB**  
P. 20, 169



**UPRIGHT 42564-CO DSNB**  
P. 169



**UPRIGHT 42564-CO USNB**  
P. 169

Contemporary Index / Index contemporain



**AARON** 40039-CO DSNB  
P. 57



**AARON** 40039-CO USNB  
P. 57



**AKERS** 41431-CO USUB  
P. 58



**ALBERTO** 40112-CO USMB  
P. 59



**ALTO** 35309-CO USUB  
P. 139



**ALYS** 50570-CO  
P. 4, 191



**ALYS** 50580-CO  
P. 191



**ANDERS** 42593-CO USNB  
P. 60



**BAILEY** 49307-CO USUB  
P. 26, 68



**BARRY** 41445-CO USUB  
P. 69



**BENNINGTON** 50660-CO  
P. 26, 192



**BENNINGTON** 50660-36/42CO  
P. 192



**BILLY** 50551-CO  
P. 193



**BILLY** 50551-36/42CO  
P. 10, 193



**BRADLEY** 40038-CO USNB  
P. 73



**BROCK** 47635-CO USUB  
P. 8, 76

Contemporary Index / Index contemporaine



**BROCK** 48635-CO USUB  
P. 76



**BROCKTON** 41585-CO USUB  
P. 77



**BROWSER** 41542-CO USUB  
P. 78



**BRYCE** 41444-CO USNB  
P. 79



**BURTON** 50557-CO  
P. 194



**BUTTON** 42460-CO USNB  
P. 80



**CAMERON** 50696-CO  
P. 195



**CAMERON** 50796/896-CO  
P. 195



**CARBON** 50662-CO  
P. 25, 26, 196



**CARBON** 50662-36/42CO  
P. 25, 196



**CARDIN** 41430-CO USUB  
P. 81



**CLOCK** 42437-CO USNB  
P. 83



**COLETTE** 45316-CO USNB  
P. 85



**CONNOR** 42493-CO USNB  
P. 86



**CONNOR** 47593-CO USNB  
P. 86



**CONNOR** 48593-CO USNB  
P. 86



**Contemporary Index / Index contemporain**



**COREY 34560-CO USUB**  
P. 26, 87



**COREY 44560-CO USUB**  
P. 87



**CRAWFORD 50164-CO**  
P. 184



**CRAWFORD 50264-CO**  
P. 184



**CRAWFORD 50364-CO**  
P. 184



**CRAWFORD 50464-CO**  
P. 183



**CRAWFORD 50764-CO**  
P. 183



**CRESCENT 39123-CO USMB**  
P. 88



**CRESCENT 49123-CO USMB**  
P. 88



**DALIA 50507-CO**  
P. 197



**DALIA 50507-38/42CO**  
P. 197



**DALIA XL 50547-CO**  
P. 198



**DARCY 30574-CO USUB**  
P. 24, 91



**DARCY 40574-CO USUB**  
P. 91



**DARLENE 30573-CO USUB**  
P. 92



**DARLENE 40573-CO USUB**  
P. 24, 92



**DEREK** 41443-CO USMB  
P. 93



**DIRK** 50634-CO  
P. 199



**DIRK** 50734/834-CO  
P. 199



**DRYDEN** 30409-CO DSNB  
P. 179



**DRYDEN** 30409-CO USNB  
P. 179



**DRYDEN** 30419-CO DSNB  
P. 179



**DRYDEN** 30419-CO USNB  
P. 179



**DUNCAN** 41540-CO USUB  
P. 95



**EASTON** 30535-CO USUB  
P. 6, 96



**EASTON** 41535-CO USUB  
P. 6, 96



**EDWIN** 35198-CO USMB  
P. 97



**EDWIN** 41498-CO USMB  
P. 98



**EDWIN** 49198-CO USMB  
P. 98



**ELIOT** 50071-PACO  
P. 200



**ELLER** 44542-CO USUB  
P. 101

**Contemporary Index / Index contemporain**



**ELMIRA 30530-CO USUB**  
P. 102



**ELMIRA 41530-CO USUB**  
P. 102



**ETHAN 49308-CO USUB**  
P. 103



**ETHAN PLUS 49309-CO USUB**  
P. 103



**FAIRFIELD 45314-CO USUB**  
P. 16, 104



**FAIRFIELD PLUS 45313-CO USUB**  
P. 104



**GENESIS 50536-CO**  
P. 201



**GENESIS 50536-36/42CO**  
P. 201



**GRISSOM 30560-CO USUB**  
P. 18, 108



**GRISSOM PLUS 30561-CO USUB**  
P. 108



**GRISSOM 41560-CO USUB**  
P. 18, 108



**HANSON 45409-CO USUB**  
P. 110



**HANSON PLUS 45405-CO USUB**  
P. 110



**HARRISON 50668-CO**  
P. 202



**HARRISON 50668-36/42CO**  
P. 202



**HARTMAN 44573-CO USUB**  
P. 111





**HINT** 39202-CO USWB  
P. 112



**HINT** 40202-CO USWB  
P. 112



**JACOB** 34572-CO USUB  
P. 114



**JACOB** 44572-CO USUB  
P. 114



**JOAN** 30237-CO USUB  
P. 117, 188



**JONAS** 30137-CO USUB  
P. 117



**JONAS** 41437-CO USUB  
P. 117



**JUDY** 50550-CO  
P. 203



**JUDY** 50550-36/42CO  
P. 203



**KRIS** 40494-CO USUB  
P. 119



**LARKIN** 44570-CO USMB  
P. 124



**LARRY** 35313-CO USUB  
P. 144



**LEO** 35305-CO USUB  
P. 139



**LIDYA** 50583-PACO  
P. 206



**LINK** 50552-CO  
P. 207

**Contemporary Index / Index contemporain**



**LINK 50553-CO**  
P. 207



**LINK 50554-36/42CO**  
P. 208



**MALLOY 50266-CO**  
P. 180



**MALLOY 50366-CO**  
P. 181



**MALLOY 50466-CO**  
P. 182



**MARLON 35409-CO USUB**  
P. 131



**MELROSE 35408-CO USUB**  
P. 131



**MELROSE 45408-CO USUB**  
P. 132



**MINTO 41548-CO USUB**  
P. 130



**MITCHELL 35405-CO USUB**  
P. 131



**MONROE 30474-CO USUB**  
P. 176



**MONROE 30478-CO USUB**  
P. 176



**MONROE 35404-CO USUB**  
P. 131



**MONROE 45404-CO USUB**  
P. 132



**MORIS 50571-CO**  
P. 210



**MORIS 50581-CO**  
P. 210



**MUNICH 30425-CO USUB**  
P. 189



**NATHAN 40033-CO USNB**  
P. 133



**NICHOLSON 50667-CO**  
P. 19, 211



**NICHOLSON 50667-CO**  
P. 19, 211



**NOX 42534-CO USNB**  
P. 135



**OPUS 39132-CO USUB**  
P. 136



**OPUS 40132-CO USUB**  
P. 136



**OWEN 39154-CO USMB**  
P. 137



**OWEN 41454-CO USMB**  
P. 137



**PABLO 35304-CO USUB**  
P. 11, 26, 139



**PABLO 30472-CO USUB**  
P. 177



**PABLO 30473-CO USUB**  
P. 177



**PABLO 40372-CO USUB**  
P. 177



**PABLO 49304-CO USUB**  
P. 140



**PABLO PLUS 49305-CO USUB**  
P. 140



**Contemporary Index / Index contemporain**



**PACEY** 35319-CO USUB  
P. 144



**PARKER** 44412-CO USUB  
P. 141



**PAUL** 49104-CO USMB  
P. 142



**PAYTON** 30103-CO USUB  
P. 143



**PAYTON** 40103-CO USUB  
P. 143



**PEDRO** 35308-CO USUB  
P. 139



**PENNY** 35318-CO USUB  
P. 144



**PERRY** 35312-CO USUB  
P. 16, 144



**PERRY** 45312-CO USUB  
P. 145



**PERRY PLUS** 45315-CO USUB  
P. 145



**RADCLIFF** 41537-CO USUB  
P. 147



**RADCLIFF** 41557-CO USUB  
P. 147



**REGENT** 30576-CO USUB  
P. 149



**REGENT** 41576-CO USUB  
P. 149



**REGENT** 41586-CO USUB  
P. 149



**RENDER** 41543-CO USMB  
P. 150



**RICARD 50664-CO**  
P. 216



**RICARD 50664-36/42CO**  
P. 216



**ROBERT 50698-CO**  
P. 217



**ROBERT 50798/898-CO**  
P. 217



**RONNY 41442-CO USUB**  
P. 151



**RONNY 47642-CO USUB**  
P. 151



**RONNY 48642-CO USUB**  
P. 151



**RUDY 42442-CO USNB**  
P. 152



**RYAN 40034-CO USNB**  
P. 154



**SINCLAIR 44501-CO USNB**  
P. 156



**SINGAPORE 30435-CO USUB**  
P. 8, 18, 190



**STATEN 41474-CO USUB**  
P. 158



**STINSON 41545-CO USUB**  
P. 159



**SWAN 42496-CO USNB**  
P. 160



**SWICE 42444-CO USNB**  
P. 161



**TORI 39124-CO USMB**  
P. 163

## Contemporary Index / Index contemporain



**TORI** 39144-CO USMB  
P. 163



**TOWER** 41475-CO USUB  
P. 164



**TRAVIS** 44443-CO USUB  
P. 165



**TURBO** 41493-CO USMB  
P. 166



**WASHINGTON** 30303-CO USMB  
P. 10, 170



**WASHINGTON** 40303-CO USMB  
P. 10, 170



**WEBBER** 30330-CO USUB  
P. 171



**WEBBER** 41330-CO USUB  
P. 171



**WEMBLEY** 41578-CO USUB  
P. 173



**WESTON** 30534-CO USUB  
P. 4, 174



**WESTON** 41534-CO USUB  
P. 4, 174



**WILBUR** 39570-CO USUB  
P. 175



**WILBUR** 41570-CO USUB  
P. 175





**ANGELINA** 30227-CO DSDB  
P. 22, 61



**ANGELINA** 40227-CO DSDB  
P. 22, 61



**ANNABELLE** 35219-CO DSDB  
P. 62



**ANNABELLE** 35219-CO USDB  
P. 62



**ANNABELLE** 35219-CO USWB  
P. 62



**ANNABELLE** 35419-CO USDB  
P. 63



**ANNABELLE** 35419-CO USWB  
P. 63



**ANNABELLE** 41419-CO DSDB  
P. 64



**ANNABELLE** 41419-CO USDB  
P. 64



**ANNABELLE** 41419-CO USWB  
P. 64



**BOURBON** 41522-CO USWB  
P. 72



**BRIDGET** 30575-CO USUB  
P. 22, 74



**BRIDGET** 49575-CO USUB  
P. 74



**COLETTE** 35316-CO USWB  
P. 85



**CYNTHIA** 35211-CO USDB  
P. 89



**CYNTHIA** 35211-CO USWB  
P. 90

Transitional Index / Index transitionnel



**CYNTHIA** 35411-CO USDB  
P. 89



**CYNTHIA** 35411-CO USWB  
P. 90



**CYNTHIA** 41411-CO USDB  
P. 89



**CYNTHIA** 41411-CO USWB  
P. 90



**ELEANOR** 35210-CO USDB  
P. 99



**ELEANOR** 35210-CO USWB  
P. 99



**ELEANOR** 35410-CO USDB  
P. 99



**ELEANOR** 35410-CO USWB  
P. 99



**ELEANOR** 41410-CO USDB  
P. 100



**ELEANOR** 41410-CO USWB  
P. 100



**GARDEN** 41488-CO USMB  
P. 105



**GRACE** 42414-CO USNB  
P. 107



**HISTORIAN** 41402-CO USWB  
P. 113



**KAI** 50609-CO  
P. 10, 204



**KAI** 50709/809-CO  
P. 204



**KYLE** 35214-CO DSDB  
P. 120



**KYLE 35214-CO USDB**  
P. 120



**KYLE 35214-CO USWB**  
P. 120



**KYLE 35414-CO USDB**  
P. 121



**KYLE 35414-CO USWB**  
P. 121



**KYLE 41414-CO DSDB**  
P. 122



**KYLE 41414-CO USDB**  
P. 122



**KYLE 41414-CO USWB**  
P. 122



**KYLE 49224-CO DSDB**  
P. 123



**KYLE 49224-CO USDB**  
P. 123



**KYLE 49224-CO USWB**  
P. 123



**MADISON 41406-CO USWB**  
P. 126



**MARCUS 39151-CO USMB**  
P. 127



**MARCUS 41451-CO USMB**  
P. 127



**MARTINA 50538-CO**  
P. 209



**MEADOW 41466-CO USMB**  
P. 128



**MILLER 40035-CO USNB**  
P. 129



**Transitional Index / Index transitionnel**



**NEST 41477-CO DSMB**  
P. 134



**NEST 41477-CO USMB**  
P. 134



**OXFORD 41510-CO USUB**  
P. 138



**PENELOPE 50601-CO**  
P. 215



**PENELOPE 50701/801-CO**  
P. 215



**PHYLO 42402-CO USNB**  
P. 146



**SALTON 50500-CO**  
P. 22, 218



**SALTON 50500-36/42CO**  
P. 22, 218



**WELLINGTON 41516-CO USMB**  
P. 172



40039-CO DSNB

**NON SWIVEL STOOL**  
Distressed solid wood seat

**TABOURET NON PIVOTANT**  
Siège en bois massif usé

Metal and wood colors shown / Couleurs de métal et de bois montrées : Magnetite (24) / Stone dust (89)



40039-CO USNB

**NON SWIVEL STOOL**  
Upholstered seat

**TABOURET NON PIVOTANT**  
Siège rembourré

Metal color shown / Couleur de métal montrée : Magnetite (24)

**MEASUREMENTS / MESURES**

		W/L in/po	D/P in/po	H in/po	S in/po	A in/po	COM S* yd/vg	COM BR* yd/vg	W/P lb
<b>40039-26CO</b>	<b>DSNB</b>	15	15	25 1/2	25 1/2	—	—	—	18
<b>40039-30CO</b>	<b>DSNB</b>	15	15	29 1/2	29 1/2	—	—	—	19
<b>40039-26CO</b>	<b>USNB</b>	15	15	26 3/4	3/4	—	0.2919	—	15
<b>40039-30CO</b>	<b>USNB</b>	15	15	30 3/4	30 3/4	—	0.2919	—	16

\* Refer to page 253 for accurate COM calculations / Référez-vous à la page 253 pour des calculs précis de COM

# Akers



41431-CO USUB

**SWIVEL STOOL**  
(without memory return)

Upholstered seat and  
backrest with metal armrests

Metal color shown/ Couleur de métal montrée : Magnetite (24)

**TABOURET PIVOTANT**  
(sans mécanisme à mémoire)

Siège et dossier rembourrés  
avec appuis-bras en métal

## MEASUREMENTS / MESURES

		W/L in/ po	D/P in/ po	H in/ po	S in/ po	A in/ po	COM S* yd/ vg	COM BR* yd/ vg	W/P lb
<b>41431-26CO</b>	<b>USUB</b>	21	20 3/4	39	26 5/8	34 3/4	0.338	0.236	34
<b>41431-30CO</b>	<b>USUB</b>	21	20 3/4	43	30 5/8	38 3/4	0.338	0.236	35

\* Refer to page 253 for accurate COM calculations/ Référez-vous à la page 253 pour des calculs précis de COM





40112-CO DSMB

**NON SWIVEL STOOL**  
Distressed solid wood seat  
and metal backrest

**TABOURET NON  
PIVOTANT**  
*Siège en bois massif usé  
et dossier en métal*

Metal and wood colors shown / Couleurs de métal et de bois montrées :  
Harley (51) / Toasty (87)



40112-CO USMB

**NON SWIVEL STOOL**  
Upholstered seat  
and metal backrest

**TABOURET NON  
PIVOTANT**  
*Siège rembourré et  
dossier en métal*

Metal color shown / Couleur de métal montrée : Magnétite (24)

## MEASUREMENTS / MESURES

		W/L	D/P	H	S	A	COM S*	COM BR*	W/P
		in/po	in/po	in/po	in/po	in/po	yd/vg	yd/vg	lb
40112-26CO	DSMB	18	19	35 7/8	25 1/8	—	—	—	16
40112-30CO	DSMB	18	19	39 7/8	29 1/8	—	—	—	17
40112-26CO	USMB	18	19	35 7/8	26 5/8	—	0.338	—	15.5
40112-30CO	USMB	18	19	39 7/8	30 5/8	—	0.338	—	16.5

\* Refer to page 253 for accurate COM calculations / Référez-vous à la page 253 pour des calculs précis de COM

# Anders



**NEW / NOUVEAU**

**42593-CO USNB**

**SWIVEL STOOL**  
(without memory return)

Upholstered seat

**TABOURET PIVOTANT**  
(sans mécanisme à mémoire)

Siège rembourré

Metal color shown/ Couleur de métal montrée : Titanium (56)

## MEASUREMENTS / MESURES

		W/L	D/P	H	S	A	COM S*	COM BR*	W/P
		in/ po	in/ po	in/ po	in/ po	in/ po	yd/ vg	yd/ vg	lb
<b>42593-26CO</b>	<b>USNB</b>	16 1/2	16 1/2	26	26	—	0.292	—	16.5
<b>42593-30CO</b>	<b>USNB</b>	17 3/4	17 3/4	30	30	—	0.292	—	17.5
<b>42593-34CO</b>	<b>USNB</b>	18 3/4	18 3/4	34	34	—	0.292	—	18.5

\* Refer to page 253 for accurate COM calculations/ Référez-vous à la page 253 pour des calculs précis de COM



**NEW / NOUVEAU**

**30227-CO DSDB**

**CHAIR**

Distressed solid wood seat and accent with metal backrest

**CHAISE**

*Siège et accent en bois massif usé avec dossier en métal*

Metal and wood colors shown / Couleurs de métal et de bois montrées : Vanilla (68)/Stone dust (89)



**NEW / NOUVEAU**

**40227-CO DSDB**

**NON SWIVEL STOOL**

Distressed solid wood seat and accent with metal backrest

**TABOURET NON PIVOTANT**

*Siège et accent en bois massif usé avec dossier en métal*

Metal and wood colors shown / Couleurs de métal et de bois montrées : Vanilla (68)/Stone dust (89)

**MEASUREMENTS / MESURES**

		W/L in/po	D/P in/po	H in/po	S in/po	A in/po	COM S* yd/vg	COM BR* yd/vg	W/P lb
<b>30227-CO</b>	<b>DSDB</b>	21 5/8	23	35 3/4	18 3/8	—	—	—	24
<b>40227-26CO</b>	<b>DSDB</b>	21 5/8	22 3/4	40	26	—	—	—	27
<b>40227-30CO</b>	<b>DSDB</b>	21 5/8	22 3/4	44	30	—	—	—	28

\* Refer to page 253 for accurate COM calculations / Référez-vous à la page 253 pour des calculs précis de COM



# Annabelle



35219-CO DSDB

**CHAIR**

Distressed solid wood seat and accent with metal backrest

**CHAISE**

*Siège et accent en bois massif usé avec dossier en métal*

Metal and wood colors shown  
*Couleurs de métal et de bois montrées :*  
Snow (63)/Pretzel (93)



35219-CO USWB

**CHAIR**

Upholstered seat and metal backrest with solid wood accent

**CHAISE**

*Siège rembourré et dossier en métal avec accent en bois massif*

Metal and wood colors shown/*Couleurs de métal et de bois montrées :*  
Oxidado (52) / -



35219-CO USDB

**CHAIR**

Upholstered seat and metal backrest with distressed solid wood accent

**CHAISE**

*Siège rembourré et dossier en métal avec accent en bois massif usé*

Metal and wood colors shown  
*Couleurs de métal et de bois montrées :*  
Snow (63)/Pretzel (93)

## MEASUREMENTS / MESURES

		W/L in/po	D/P in/po	H in/po	S in/po	A in/po	COM S* yd/vg	COM BR* yd/vg	W/P lb
35219-CO	DSDB	19 1/2	23	39	17 1/8	—	—	—	22
35219-CO	USDB	19 1/2	23	39	19 1/8	—	0.382	—	18
35219-CO	USWB	19 1/2	23	39	19 1/8	—	0.382	—	18

\* Refer to page 253 for accurate COM calculations / *Référez-vous à la page 253 pour des calculs précis de COM*



35419-CO USDB

**ARMCHAIR**

Upholstered seat and metal armrests and backrest with distressed solid wood accent

**CHAISE AVEC APPUIS-BRAS**

*Siège rembourré et appuis-bras et dossier en métal avec accent en bois massif usé*

Metal and wood colors shown/ Couleurs de métal et de bois montrées : Oxidado (52)/Pretzel (93)



35419-CO USWB

**ARMCHAIR**

Upholstered seat and metal armrests and backrest with solid wood accent

**CHAISE AVEC APPUIS-BRAS**

*Siège rembourré et appuis-bras et dossier en métal avec accent en bois massif*

Metal and wood colors shown/ Couleurs de métal et de bois montrées : Oxidado (52)/-

**MEASUREMENTS / MESURES**

		W/L in/po	D/P in/po	H in/po	S in/po	A in/po	COM S* yd/vg	COM BR* yd/vg	W/P lb
35419-CO	DSDB	26	23 1/8	39	17 1/8	25 7/8	—	—	22
35419-CO	USDB	26	23	39	19 1/8	25 7/8	0.382	—	18
35419-CO	USWB	26	23	39	19 1/8	25 7/8	0.382	—	18

\* Refer to page 253 for accurate COM calculations/ Référez-vous à la page 253 pour des calculs précis de COM

# Annabelle



41419-CO DSDB

**SWIVEL STOOL**

(with memory return)

Distressed solid wood seat and accent with metal backrest

**TABOURET PIVOTANT**

(avec mécanisme à mémoire)

*Siège et accent en bois massif usé avec dossier en métal*

Metal and wood colors shown  
Couleurs de métal et de bois montrées :  
Snow (63)/Pretzel (93)



41419-CO USWB

**SWIVEL STOOL**

(with memory return)

Upholstered seat and metal backrest with distressed solid wood accent

**TABOURET PIVOTANT**

(avec mécanisme à mémoire)

*Siège rembourré et dossier en métal avec accent en bois massif*

Metal and wood colors shown / Couleurs de métal et de bois montrées :  
Black coral / Noir corail (25) / -



41419-CO USDB

**SWIVEL STOOL**

(with memory return)

Upholstered seat and metal backrest with distressed solid wood accent

**TABOURET PIVOTANT**

(avec mécanisme à mémoire)

*Siège rembourré et dossier en métal avec accent en bois massif usé*

Metal and wood colors shown  
Couleurs de métal et de bois montrées :  
Snow (63)/Pretzel (93)

## MEASUREMENTS / MESURES

		W/L	D/P	H	S	A	COM S*	COM BR*	W/P
		in/ po	in/ po	in/ po	in/ po	in/ po	yd/ vg	yd/ vg	lb
41419-26CO	DSDB	18 1/2	21	45 1/2	25 1/4	—	—	—	31.5
41419-30CO	DSDB	18 1/2	21	49 1/2	29 1/4	—	—	—	32.5
41419-34CO	DSDB	18 1/2	21 1/2	53 1/2	33 1/4	—	—	—	33.5
41419-26CO	USDB	18 1/2	21	45 1/2	26 5/8	—	0.329	—	28.5
41419-30CO	USDB	18 1/2	21	49 1/2	30 5/8	—	0.329	—	29.5
41419-34CO	USDB	18 1/2	21 1/2	53 1/2	34 5/8	—	0.329	—	30.5
41419-26CO	USWB	18 1/2	21	45 1/2	27	—	0.329	—	28.5
41419-30CO	USWB	18 1/2	21	49 1/2	30 7/8	—	0.329	—	29.5
41419-34CO	USWB	18 1/2	21 1/2	53 1/2	34 5/8	—	0.329	—	30.5

\* Refer to page 253 for accurate COM calculations / Référez-vous à la page 253 pour des calculs précis de COM



## 30263-CO DSDB

### CHAIR

Distressed solid wood seat and backrest

### CHAISE

*Siège et dossier en bois massif usé*

Metal and wood colors shown  
Couleurs de métal et de bois montrées : Harley (51)/Stone dust (89)



Stool version available  
See Upright on page 169  
Version tabouret disponible  
Voir Upright à la page 169



## 30263-CO USDB

### CHAIR

Upholstered seat and distressed solid wood backrest

### CHAISE

*Siège rembourré et dossier en bois massif usé*

Metal and wood colors shown  
Couleurs de métal et de bois montrées : Harley (51)/Stone dust (89)



## 30563-CO USMB

### CHAIR

Upholstered seat and metal backrest

### CHAISE

*Siège rembourré et dossier en métal*

Metal color shown  
Couleur de métal montrée : Harley (51)

## 30563-CO DSMB

### CHAIR

Distressed solid wood seat and metal backrest

### CHAISE

*Siège en bois massif usé et dossier en métal*

Metal and wood colors shown / Couleurs de métal et de bois montrées : Harley (51)/Stone dust (89)

## MEASUREMENTS / MESURES

		W/L in/po	D/P in/po	H in/po	S in/po	A in/po	COM S* yd/vg	COM BR* yd/vg	W/P lb
30263-CO	DSDB	18	21 3/4	32 1/4	17 1/2	—	—	—	22
30263-CO	USDB	18	21 3/4	32 1/4	19 1/8	—	0.338	—	18
30563-CO	DSMB	18	21	32 3/4	17 1/2	—	—	—	21.5
30563-CO	USMB	18	21	32 3/4	19 1/8	—	0.338	—	17.5

\* Refer to page 253 for accurate COM calculations / Référez-vous à la page 253 pour des calculs précis de COM



# Architect



40263-CO DSDB

**SCREW STOOL**

Distressed solid wood seat and backrest

**TABOURET À VIS**

*Siège et dossier en bois massif usé*

Metal and wood colors shown  
*Couleurs de métal et de bois montrées :*  
Harley (51)/Toasty (87)



40263-CO USDB

**SCREW STOOL**

Upholstered seat and distressed solid wood backrest

**TABOURET À VIS**

*Siège rembourré et dossier en bois massif usé*

Metal and wood colors shown  
*Couleurs de métal et de bois montrées :*  
Harley (51)/Toasty (87)



40563-CO USMB

**SCREW STOOL**

Upholstered seat and metal backrest

**TABOURET À VIS**

*Siège rembourré et dossier en métal*

Metal color shown  
*Couleur de métal montrée :* Harley (51)



40563-CO DSMB

**SCREW STOOL**

Distressed solid wood seat and metal backrest

**TABOURET À VIS**

*Siège en bois massif usé et dossier en métal*

Metal and wood colors shown/*Couleurs de métal et de bois montrées :*  
Harley (51)/Toasty (87)

**MEASUREMENTS / MESURES**

		W/L in/po	D/P in/po	H in/po	S in/po	A in/po	COM S* yd/vg	COM BR* yd/vg	W/P lb
<b>40263-CO</b>	<b>DSDB</b>	16 1/4	19 7/8	37 - 42 3/8	25 - 30 3/8	—	—	—	23.0
<b>40263-CO</b>	<b>USDB</b>	16 1/4	19 7/8	37 - 42 3/8	26 - 31 3/8	—	0.280	—	20.5
<b>40563-CO</b>	<b>DSMB</b>	16 1/4	19 7/8	37 - 42 3/8	25 - 30 3/8	—	—	—	21.0
<b>40563-CO</b>	<b>USMB</b>	16 1/4	19 7/8	37 - 42 3/8	26 - 31 3/8	—	0.280	—	18.5

\* Refer to page 253 for accurate COM calculations / *Référez-vous à la page 253 pour des calculs précis de COM*



42563-CO DSNB

**SCREW STOOL**

Distressed solid wood seat

**TABOURET À VIS**

*Siège en bois massif usé*

Metal and wood colors shown/ Couleurs de métal et de bois montrées : Harley (51)/ Toasty (87)



42563-CO USNB

**SCREW STOOL**

Upholstered seat

**TABOURET À VIS**

*Siège rembourré*

Metal color shown/ Couleur de métal montrée : Harley (51)

**MEASUREMENTS / MESURES**

		W/L in./po	D/P in./po	H in./po	S in./po	A in./po	COM S* yd./vg	COM BR* yd./vg	W/P lb
42563-CO	DSNB	16 1/4	16 1/4	25 - 30 3/8	25 - 30 3/8	—	—	—	21.0
42563-CO	USNB	16 1/4	16 1/4	26 - 31 3/8	26 - 31 3/8	—	0.280	—	19.0

\* Refer to page 253 for accurate COM calculations/ Référez-vous à la page 253 pour des calculs précis de COM

# Bailey



**NEW / NOUVEAU**

**49307-CO USUB**

**NON SWIVEL STOOL**  
Upholstered seat and  
backrest

**TABOURET NON  
PIVOTANT**  
Siège et dossier  
rembourrés

Metal color shown / Couleur de métal montrée : Black coral/Noir corail (25)

## MEASUREMENTS / MESURES

		W/L in/po	D/P in/po	H in/po	S in/po	A in/po	COM S* yd/vg	COM BR* yd/vg	W/P lb
<b>49307-26CO</b>	<b>USUB</b>	22 1/4	22	32 3/4	26 3/4	—	1.495	—	24.5
<b>49307-30CO</b>	<b>USUB</b>	22 1/4	22	36 3/4	30 3/4	—	1.495	—	26

\* Refer to page 253 for accurate COM calculations / Référez-vous à la page 253 pour des calculs précis de COM

# Barry



Back view / Vue arrière



Backless version available  
See Swice on page 161  
Version sans dossier disponible  
Voir Swice à la page 161



41445-CO USUB

**SWIVEL STOOL**  
(without memory return)

Upholstered seat and  
backrest

Metal color shown / Couleur de métal montrée : -

**TABOURET PIVOTANT**  
(sans mécanisme à mémoire)

Siège et dossier  
rembourrés

## MEASUREMENTS / MESURES

		W/L in/po	D/P in/po	H in/po	S in/po	A in/po	COM S* yd/vg	COM BR* yd/vg	W/P lb
<b>41445-26CO</b>	<b>USUB</b>	17 3/4	21	36 1/2	26 1/8	—	0.34	0.259	20.5
<b>41445-30CO</b>	<b>USUB</b>	17 3/4	21	40 1/2	30 1/8	—	0.34	0.259	21.5
<b>41445-34CO</b>	<b>USUB</b>	17 3/4	21	44 1/2	34 1/8	—	0.34	0.259	22.5

\* Refer to page 253 for accurate COM calculations / Référez-vous à la page 253 pour des calculs précis de COM



# Bean



39268-CO USDB

**CHAIR**

Upholstered seat and distressed solid wood backrest

**CHAISE**

*Siège rembourré et dossier en bois massif usé*

Metal and wood colors shown  
Couleurs de métal et de bois montrées : Oxidado (52)/Sand dust (86)



39568-CO DSMB

**CHAIR**

Distressed solid wood seat and metal backrest

**CHAISE**

*Siège en bois massif usé et dossier en métal*

Metal and wood colors shown  
Couleurs de métal et de bois montrées : Oxidado (52)/Sand dust (86)



Back view/ Vue arrière



39568-CO USMB

**CHAIR**

Upholstered seat and metal backrest

**CHAISE**

*Siège rembourré et dossier en métal*

Metal color shown/Couleur de métal montrée : Oxidado (52)



39268-CO DSDB

**CHAIR**

Distressed solid wood seat and backrest

**CHAISE**

*Siège et dossier en bois massif usé*

Metal and wood colors shown/Couleurs de métal et de bois montrées : Oxidado (52)/Sand dust (86)

**MEASUREMENTS/MESURES**

		W/L in/po	D/P in/po	H in/po	S in/po	A in/po	COM S* yd/vg	COM BR* yd/vg	W/P lb
39268-CO	DSDB	16 3/4	20 1/2	33 1/4	17 3/4	—	—	—	16
39268-CO	USDB	17 1/2	20 3/4	33 1/4	19 1/8	—	0.329	—	12.5
39568-CO	DSMB	16 3/4	21 1/2	34	17 3/4	—	—	—	16
39568-CO	USMB	17 1/2	21 3/4	34	19 1/8	—	0.329	—	12.5

\* Refer to page 253 for accurate COM calculations/Référez-vous à la page 253 pour des calculs précis de COM

# Bean



41268-CO USDB

**SWIVEL STOOL**  
(without memory return)

Upholstered seat and distressed solid wood backrest

**TABOURET PIVOTANT**  
(sans mécanisme à mémoire)

*Siège rembourré et dossier en bois massif usé*

Metal and wood colors shown  
*Couleurs de métal et de bois montrées :*  
Harley (51) / Toasty (87)



41568-CO DSMB

**SWIVEL STOOL**  
(without memory return)

Distressed solid wood seat and metal backrest

**TABOURET PIVOTANT**  
(sans mécanisme à mémoire)

*Siège en bois massif usé et dossier en métal*

Metal and wood colors shown  
*Couleurs de métal et de bois montrées :*  
Harley (51) / Toasty (87)



Back view / *Vue arrière*



41568-CO USMB

**SWIVEL STOOL**  
(without memory return)

Upholstered seat and metal backrest

**TABOURET PIVOTANT**  
(sans mécanisme à mémoire)

*Siège rembourré et dossier en métal*

Metal color shown / *Couleur de métal montrée :* Harley (51)



41268-CO DSDB

**SWIVEL STOOL**  
(without memory return)

Distressed solid wood seat and backrest

Metal and wood colors shown / *Couleurs de métal et de bois montrées :*  
Harley (51) / Toasty (87)

**TABOURET PIVOTANT**  
(sans mécanisme à mémoire)

*Siège et dossier en bois massif usé*

## MEASUREMENTS / MESURES

		W/L in/po	D/P in/po	H in/po	S in/po	A in/po	COM S* yd/vg	COM BR* yd/vg	W/P lb
41268-26CO	DSDB	16 3/4	20 1/2	38 1/2	25 1/2	—	—	—	24.0
41268-30CO	DSDB	16 3/4	20 1/2	42 1/2	29 1/2	—	—	—	25.0
41268-26CO	USDB	17 1/2	20 1/2	38 1/2	26 7/8	—	0.329	—	20.5
41268-30CO	USDB	17 1/2	20 1/2	42 1/2	30 7/8	—	0.329	—	21.5
41568-26CO	DSMB	16 3/4	21	39 3/8	25 1/2	—	—	—	24.0
41568-30CO	DSMB	16 3/4	21	43 3/8	29 1/2	—	—	—	25.0
41568-26CO	USMB	17 1/2	21	39 3/8	26 7/8	—	0.329	—	20.5
41568-30CO	USMB	17 1/2	21	43 3/8	30 7/8	—	0.329	—	21.5

\* Refer to page 253 for accurate COM calculations / *Référez-vous à la page 253 pour des calculs précis de COM*

# Bourbon



Backless version available  
See Swan on page 160  
*Version sans dossier disponible*  
Voir Swan à la page 160

41522-CO USWB

**SWIVEL STOOL**  
(with memory return)

Upholstered seat and  
metal backrest with solid  
wood accent

**TABOURET PIVOTANT**  
(avec mécanisme à mémoire)

*Siège rembourré et dossier  
en métal avec accent en  
bois massif*

Metal and wood colors shown / *Couleurs de métal et de bois montrées :*  
Cobrizo (75)/-

## MEASUREMENTS / MESURES

		W/L in/po	D/P in/po	H in/po	S in/po	A in/po	COM S* yd/vg	COM BR* yd/vg	W/P lb
41522-26CO	USWB	17	20 1/2	36 1/4	25 7/8	—	0.308	—	25
41522-30CO	USWB	17	20 1/2	40 1/4	29 7/8	—	0.308	—	26

\* Refer to page 253 for accurate COM calculations / *Référez-vous à la page 253 pour des calculs précis de COM*



40038-CO DSNB

**NON SWIVEL STOOL**  
Distressed solid wood seat

**TABOURET  
NON PIVOTANT**  
*Siège en bois massif usé*

Metal and wood colors shown / *Couleurs de métal et de bois montrées :*  
Falcon (74)/Toasty (87)



40038-CO USNB

**NON SWIVEL STOOL**  
Upholstered seat

**TABOURET NON  
PIVOTANT**  
*Siège rembourré*

Metal color shown / *Couleur de métal montrée :* Magnétique (24)

## MEASUREMENTS / MESURES

		W/L in/po	D/P in/po	H in/po	S in/po	A in/po	COM S* yd/vg	COM BR* yd/vg	W/P lb
<b>40038-26CO</b>	<b>DSNB</b>	17 1/2	13 1/2	25 1/8	25 1/8	—	—	—	17
<b>40038-30CO</b>	<b>DSNB</b>	17 1/2	13 1/2	29 1/8	29 1/8	—	—	—	18
<b>40038-26CO</b>	<b>USNB</b>	17 1/2	13 1/2	26 3/8	26 3/8	—	0.331	—	13
<b>40038-30CO</b>	<b>USNB</b>	17 1/2	13 1/2	30 3/8	30 3/8	—	0.331	—	14

\* Refer to page 253 for accurate COM calculations / *Référez-vous à la page 253 pour des calculs précis de COM*



# Bridget



**NEW / NOUVEAU**

30575-CO USUB

**CHAIR**

Upholstered seat and backrest

**CHAISE**

*Siège et dossier rembourrés*

Metal color shown / Couleur de métal montrée : Oxidado (52)



**NEW / NOUVEAU**

49575-CO USUB

**NON SWIVEL STOOL**

Upholstered seat and backrest

**TABOURET NON PIVOTANT**

*Siège et dossier rembourrés*

Metal color shown / Couleur de métal montrée : Oxidado (52)

## MEASUREMENTS / MESURES

		W/L in/po	D/P in/po	H in/po	S in/po	A in/po	COM S* yd/vg	COM BR* yd/vg	W/P lb
<b>30575-CO</b>	<b>USUB</b>	21	25 1/4	37 1/2	19	—	1.607	—	28
<b>49575-26CO</b>	<b>USUB</b>	21	24 1/4	46 1/4	27 3/4	—	1.607	—	29
<b>49575-30CO</b>	<b>USUB</b>	21	24 1/4	50 1/4	31 3/4	—	1.607	—	30

\* Refer to page 253 for accurate COM calculations / Référez-vous à la page 253 pour des calculs précis de COM



30536-CO USUB

**CHAIR**

Upholstered seat and backrest

Metal color shown/ Couleur de métal montrée : Harley (51)

**CHAISE**

Siège et dossier rembourrés



41536-CO USUB

**SWIVEL STOOL**

(without memory return)

Upholstered seat and backrest

Metal color shown/ Couleur de métal montrée : Harley (51)

**TABOURET PIVOTANT**

(sans mécanisme à mémoire)

Siège et dossier rembourrés

This design is now available as a non swivel stool. Please contact us for details and pricing./ Ce modèle est maintenant disponible en version non pivotante. Veuillez nous contacter pour les détails et les prix.

**MEASUREMENTS / MESURES**

		W/L in/po	D/P in/po	H in/po	S in/po	A in/po	COM S* yd/vg	COM BR* yd/vg	W/P lb
<b>30536-CO</b>	<b>USUB</b>	17 7/8	22 1/4	33	19 1/8	—	0.488	0.442	22
<b>41536-26CO</b>	<b>USUB</b>	18 3/4	22 1/2	41 1/4	27	—	0.488	0.442	28.5
<b>41536-30CO</b>	<b>USUB</b>	18 3/4	22 1/2	45 1/4	31	—	0.488	0.442	29.5
<b>41536-34CO</b>	<b>USUB</b>	18 3/4	22 1/2	49 1/4	35	—	0.488	0.442	30.5

\* Refer to page 253 for accurate COM calculations/ Référez-vous à la page 253 pour des calculs précis de COM



Back view / Vue arrière



47635-CO USUB

**PEDESTAL SWIVEL STOOL**

(without memory return)

Upholstered seat and backrest  
Round plate

Metal color shown / Couleur de métal montrée : Titanium (56)

**TABOURET PIÉDESTAL PIVOTANT**

(sans mécanisme à mémoire)

Siège et dossier rembourrés  
Plaque ronde



48635-CO USUB

**BOLT DOWN SWIVEL STOOL**

(without memory return)

Upholstered seat and backrest

Metal color shown / Couleur de métal montrée : Titanium (56)

**TABOURET PIVOTANT VISSÉ AU PLANCHER**

(sans mécanisme à mémoire)

Siège et dossier rembourrés

**MEASUREMENTS / MESURES**

		W/L	D/P	H	S	A	COM S*	COM BR*	W/P
		in/ po	in/ po	in/ po	in/ po	in/ po	yd/ vg	yd/ vg	lb
<b>47635-26CO</b>	<b>USUB</b>	18	19 3/4	36 1/4	26 1/8	—	0.315	0.275	43.5
<b>47635-30CO</b>	<b>USUB</b>	18	19 3/4	40 1/4	30 1/8	—	0.315	0.275	45
<b>48635-26CO</b>	<b>USUB</b>	17 5/8	19 3/4	36 3/8	26 1/4	—	0.315	0.275	38
<b>48635-30CO</b>	<b>USUB</b>	17 5/8	19 3/4	40 3/8	30 1/4	—	0.315	0.275	39

\* Refer to page 253 for accurate COM calculations / Référez-vous à la page 253 pour des calculs précis de COM



Back view / Vue arrière



41585-CO USUB

**SWIVEL STOOL**  
(without memory return)

Upholstered seat and backrest

Metal color shown / Couleur de métal montrée : Titanium (56)

**TABOURET PIVOTANT**  
(sans mécanisme à mémoire)

Siège et dossier rembourrés

## MEASUREMENTS / MESURES

		W/L in/po	D/P in/po	H in/po	S in/po	A in/po	COM S* yd/vg	COM BR* yd/vg	W/P lb
<b>41585-26CO</b>	<b>USUB</b>	17 1/4	20 3/8	37 3/4	26 7/8	—	0.315	0.275	24.5
<b>41585-30CO</b>	<b>USUB</b>	17 1/4	20 3/8	41 3/4	30 7/8	—	0.315	0.275	25

\* Refer to page 253 for accurate COM calculations / Référez-vous à la page 253 pour des calculs précis de COM



# Browser



Backless version available  
See Swice on page 161  
Version sans dossier disponible  
Voir Swice à la page 161

41542-CO USUB

## SWIVEL STOOL

(without memory return)

Upholstered seat and  
backrest

Metal color shown / Couleur de métal montrée : Cobrizo (75)

## TABOURET PIVOTANT

(sans mécanisme à mémoire)

Siège et dossier  
rembourrés

### MEASUREMENTS / MESURES

		W/L in/ po	D/P in/ po	H in/ po	S in/ po	A in/ po	COM S* yd/ vg	COM BR* yd/ vg	W/P lb
41542-26CO	USUB	21 3/4	19 1/4	32 1/4	26 1/8	—	0.315	0.519	28
41542-30CO	USUB	21 3/4	19 1/4	37 1/4	30 1/8	—	0.315	0.519	29

\* Refer to page 253 for accurate COM calculations / Référez-vous à la page 253 pour des calculs précis de COM



Top view / *Vue du dessus*



41444-CO USNB

**SWIVEL STOOL**  
(without memory return)

Upholstered seat

**TABOURET PIVOTANT**  
(sans mécanisme à mémoire)

*Siège rembourré*

Metal color shown / *Couleur de métal montrée* : Oxidado (52)

## MEASUREMENTS / MESURES

		W/L	D/P	H	S	A	COM S*	COM BR*	W/P
		in/po	in/po	in/po	in/po	in/po	yd/vg	yd/vg	lb
<b>41444-26CO</b>	<b>USNB</b>	17 3/4	18 3/8	26 1/8	26 1/8	—	0.34	—	19.5
<b>41444-30CO</b>	<b>USNB</b>	17 3/4	18 3/8	30 1/8	30 1/8	—	0.34	—	20.5
<b>41444-34CO</b>	<b>USNB</b>	17 3/4	18 7/8	34 1/8	34 1/8	—	0.34	—	22.5

\* Refer to page 253 for accurate COM calculations / *Référez-vous à la page 253 pour des calculs précis de COM*

# Button



42460-CO DSNB

**SWIVEL STOOL**  
(without memory return)

Distressed solid wood seat

Metal and wood colors shown / Couleurs de métal et de bois montrées :  
Oxidado (52)/Toasty (87)

**TABOURET PIVOTANT**  
(sans mécanisme à mémoire)

*Siège en bois massif usé*



42460-CO USNB

**SWIVEL STOOL**  
(without memory return)

Upholstered seat

Metal color shown / Couleur de métal montrée : Titanium (56)

**TABOURET PIVOTANT**  
(sans mécanisme à mémoire)

*Siège rembourré*

## MEASUREMENTS / MESURES

		W/L in/po	D/P in/po	H in/po	S in/po	A in/po	COM S* yd/vg	COM BR* yd/vg	W/P lb
<b>42460-26CO</b>	<b>DSNB</b>	16 3/8	16 3/8	26 1/4	26 1/4	—	—	—	16.5
<b>42460-30CO</b>	<b>DSNB</b>	16 3/8	16 3/8	30 1/4	30 1/4	—	—	—	17.5
<b>42460-34CO</b>	<b>DSNB</b>	16 1/2	16 1/2	33 1/4	33 1/4	—	—	—	18.5
<b>42460-26CO</b>	<b>USNB</b>	16 3/8	16 3/8	26 5/8	26 5/8	—	0.252	—	16.5
<b>42460-30CO</b>	<b>USNB</b>	16 3/8	16 3/8	30 5/8	30 5/8	—	0.252	—	17.5
<b>42460-34CO</b>	<b>USNB</b>	16 1/2	16 1/2	33 5/8	33 5/8	—	0.252	—	18.5

\* Refer to page 253 for accurate COM calculations / Référez-vous à la page 253 pour des calculs précis de COM



## 41430-CO USUB

### SWIVEL STOOL

(without memory return)

Upholstered seat and backrest with metal armrests

Metal color shown/ Couleur de métal montrée : Oxidado (52)

### TABOURET PIVOTANT

(sans mécanisme à mémoire)

Siège et dossier rembourrés avec appuis-bras en métal

## MEASUREMENTS / MESURES

		W/L	D/P	H	S	A	COM S*	COM BR*	W/P
		in/po	in/po	in/po	in/po	in/po	yd/vg	yd/vg	lb
<b>41430-26CO</b>	<b>USUB</b>	22 1/4	25 1/2	41 3/8	26 5/8	34 1/8	0.315	0.694	23.5
<b>41430-30CO</b>	<b>USUB</b>	22 1/4	25 1/2	45 3/8	30 5/8	38 1/8	0.315	0.694	25
<b>41430-34CO</b>	<b>USUB</b>	22 1/4	25 1/2	49 3/8	34 5/8	42 1/8	0.315	0.694	26.5

\* Refer to page 253 for accurate COM calculations / Référez-vous à la page 253 pour des calculs précis de COM



# Century



41549-CO DSMB

**SWIVEL STOOL**

(without memory return)

Distressed solid wood seat and metal backrest

**TABOURET PIVOTANT**

(sans mécanisme à mémoire)

Siège en bois massif usé et dossier en métal

Metal and wood colors shown / Couleurs de métal et de bois montrées : Metallo (57) / Stone dust (89)

41549-CO USMB

**SWIVEL STOOL**

(without memory return)

Upholstered seat and metal backrest

**TABOURET PIVOTANT**

(sans mécanisme à mémoire)

Siège rembourré et dossier en métal

Metal color shown / Couleur de métal montrée : Metallo (57)

## MEASUREMENTS / MESURES

		W/L in/po	D/P in/po	H in/po	S in/po	A in/po	COM S* yd/vg	COM BR* yd/vg	W/P lb
<b>41549-26CO</b>	<b>DSMB</b>	17 3/4	21 5/8	42 1/4	25 1/4	—	—	—	33
<b>41549-30CO</b>	<b>DSMB</b>	17 3/4	21 5/8	46 1/4	29 1/4	—	—	—	34
<b>41549-26CO</b>	<b>USMB</b>	17 3/4	21 5/8	42 1/4	25 1/4	—	0.3289	—	29,5
<b>41549-30CO</b>	<b>USMB</b>	17 3/4	21 5/8	46 1/4	30 1/2	—	0.3289	—	30,5

\* Refer to page 253 for accurate COM calculations / Référez-vous à la page 253 pour des calculs précis de COM



42437-CO USNB

**SWIVEL STOOL**

(without memory return)

Upholstered seat

**TABOURET PIVOTANT**

(sans mécanisme à mémoire)

Siège rembourré

Metal color shown / Couleur de métal montrée : Magnétite (24)

**MEASUREMENTS / MESURES**

		W/L in/po	D/P in/po	H in/po	S in/po	A in/po	COM S* yd/vg	COM BR* yd/vg	W/P lb
<b>42437-26CO</b>	<b>USNB</b>	17 1/8	17 1/8	26	26	—	0.315	—	18
<b>42437-30CO</b>	<b>USNB</b>	17 1/8	17 1/8	30	30	—	0.315	—	19

\* Refer to page 253 for accurate COM calculations / Référez-vous à la page 253 pour des calculs précis de COM



39667-CO USMB

**CHAIR**

Upholstered seat and metal backrest

**CHAISE**

*Siège rembourré et dossier en métal*

Metal color shown  
Couleur de métal montrée :  
Black coral/Noir corail (25)



41667-CO DSMB

**SWIVEL STOOL**

(without memory return)

Distressed solid wood seat and metal backrest

**TABOURET PIVOTANT**

(sans mécanisme à mémoire)

*Siège en bois massif usé et dossier en métal*

Metal and wood colors shown  
Couleurs de métal et de bois montrées :  
Black coral/Noir corail (25)/Toasty (87)



41667-CO USMB

**SWIVEL STOOL**

(without memory return)

Upholstered seat and metal backrest

**TABOURET PIVOTANT**

(sans mécanisme à mémoire)

*Siège rembourré et dossier en métal*

Metal color shown  
Couleur de métal montrée :  
Black coral/Noir corail (25)



39667-CO DSMB

**CHAIR**

Distressed solid wood seat and metal backrest

**CHAISE**

*Siège en bois massif usé et dossier en métal*

Metal and wood colors shown/Couleurs de métal et de bois montrées :  
Black coral/Noir corail (25)/Toasty (87)

**MEASUREMENTS / MESURES**

		W/L	D/P	H	S	A	COM S*	COM BR*	W/P
		in/ po	in/ po	in/ po	in/ po	in/ po	yd/ vg	yd/ vg	lb
<b>39667-CO DSMB</b>	<b>DSMB</b>	16 3/4	21	33 1/4	17 3/4	—	—	—	16.5
<b>39667-CO USMB</b>	<b>USMB</b>	17 1/2	21 1/4	33 1/4	19 1/8	—	0.329	—	13
<b>41667-26CO DSMB</b>	<b>DSMB</b>	16 3/4	20 3/4	40	25 1/2	—	—	—	24.5
<b>41667-30CO DSMB</b>	<b>DSMB</b>	16 3/4	20 3/4	44	29 1/2	—	—	—	25.5
<b>41667-26CO USMB</b>	<b>USMB</b>	17 1/2	20 3/4	40	26 7/8	—	0.329	—	21.5
<b>41667-30CO USMB</b>	<b>USMB</b>	17 1/2	20 3/4	44	30 7/8	—	0.329	—	22.5

\* Refer to page 253 for accurate COM calculations / Référez-vous à la page 253 pour des calculs précis de COM



35316-CO USUB

**CHAIR**

Upholstered seat and backrest

**CHAISE**

*Siège et dossier rembourrés*

Metal color shown / Couleur de métal montrée : Oxidado (52)



45316-CO USUB

**NON SWIVEL STOOL**

Upholstered seat and backrest

**TABOURET NON PIVOTANT**

*Siège et dossier rembourrés*

Metal color shown / Couleur de métal montrée : Oxidado (52)

**MEASUREMENTS / MESURES**

		W/L in/po	D/P in/po	H in/po	S in/po	A in/po	COM S* yd/vg	COM BR* yd/vg	W/P lb
<b>35316-CO</b>	<b>USUB</b>	18 1/2	24	37	19	—	0.359	0.528	17.5
<b>45316-26CO</b>	<b>USUB</b>	18 1/2	21 3/4	41 1/2	26 1/4	—	0.359	0.477	20.5
<b>45316-30CO</b>	<b>USUB</b>	18 1/2	21 3/4	46 1/2	30 1/4	—	0.359	0.477	21

\* Refer to page 253 for accurate COM calculations / Référez-vous à la page 253 pour des calculs précis de COM



# Connor



42493-CO USNB

## SWIVEL STOOL

(without memory return)

Upholstered seat

## TABOURET PIVOTANT

(sans mécanisme à mémoire)

Siège rembourré

Metal color shown  
Couleur de métal montrée :  
Titanium (56)

This design is now available as a non swivel stool. Please contact us for details and pricing.  
Ce modèle est maintenant disponible en version non pivotante. Veuillez nous contacter pour les détails et les prix.



47593-CO USNB

## PEDESTAL SWIVEL STOOL

(without memory return)

Upholstered seat

Round plate

## TABOURET PIÉDESTAL PIVOTANT

(sans mécanisme à mémoire)

Siège rembourré

Plaque ronde

Metal color shown  
Couleur de métal montrée :  
Titanium (56)



48593-CO USUB

## BOLT DOWN SWIVEL STOOL

(without memory return)

Upholstered seat

## TABOURET PIVOTANT VISSÉ AU PLANCHER

(sans mécanisme à mémoire)

Siège rembourré

Metal color shown  
Couleur de métal montrée :  
Titanium (56)



42493-CO DSNB

## SWIVEL STOOL

(without memory return)

Distressed solid wood seat

## TABOURET PIVOTANT

(sans mécanisme à mémoire)

Siège en bois massif usé

Metal and wood colors shown/ Couleurs de métal et de bois montrées :  
Black coral/Noir corail (25)/Shady (84)

This design is now available as a non swivel stool. Please contact us for details and pricing./ Ce modèle est maintenant disponible en version non pivotante. Veuillez nous contacter pour les détails et les prix.

## MEASUREMENTS / MESURES

		W/L	D/P	H	S	A	COM S*	COM BR*	W/P
		in/ po	in/ po	in/ po	in/ po	in/ po	yd/ vg	yd/ vg	lb
42493-26CO	DSNB	16 1/2	16 1/2	25 1/2	25 1/2	—	—	—	24
42493-30CO	DSNB	17 3/4	17 3/4	29 1/2	29 1/2	—	—	—	25
42493-34CO	DSNB	18 3/4	18 3/4	33 1/2	33 1/2	—	—	—	27
42493-26CO	USNB	16 1/2	16 1/2	26 7/8	26 7/8	—	0.308	—	22
42493-30CO	USNB	17 3/4	17 3/4	30 7/8	30 7/8	—	0.308	—	23
42493-34CO	USNB	18 3/4	18 3/4	34 7/8	34 7/8	—	0.308	—	24
47593-26CO	USNB	18	18	26 1/8	26 1/8	—	0.308	—	36.5
47593-30CO	USNB	18	18	30 1/8	30 1/8	—	0.308	—	37.5
48593-26CO	USNB	17 5/8	17 5/8	26 1/4	26 1/4	—	0.308	—	30.5
48593-30CO	USNB	17 5/8	17 5/8	30 1/4	30 1/4	—	0.308	—	31.5

\* Refer to page 253 for accurate COM calculations/ Référez-vous à la page 253 pour des calculs précis de COM



**NEW / NOUVEAU**

**34560-CO USUB**

**CHAIR**

Upholstered seat and backrest

**CHAISE**

*Siège et dossier rembourrés*

Metal color shown / Couleur de métal montrée : Black coral / Noir corail (25)



**NEW / NOUVEAU**

**44560-CO USUB**

**SWIVEL STOOL**

(without memory return)

Upholstered seat and backrest

**TABOURET PIVOTANT**

*(sans mécanisme à mémoire)*

*Siège et dossier rembourrés*

Metal color shown / Couleur de métal montrée : Black coral / Noir corail (25)

**MEASUREMENTS / MESURES**

		W/L	D/P	H	S	A	COM S*	COM BR*	W/P
		in/po	in/po	in/po	in/po	in/po	yd/vg	yd/vg	lb
<b>34560-CO</b>	<b>USUB</b>	22	23 1/4	30 1/2	19	27	0.418	0.972	23
<b>44560-26CO</b>	<b>USUB</b>	22	23 1/2	39 1/8	27 5/8	35 5/8	0.418	0.972	24.5
<b>44560-30CO</b>	<b>USUB</b>	22	23 1/2	43 1/8	31 5/8	39 5/8	0.418	0.972	25.5

\* Refer to page 253 for accurate COM calculations / Référez-vous à la page 253 pour des calculs précis de COM

# Crescent



39123-CO USMB

**CHAIR**

Upholstered seat and metal backrest

**CHAISE**

*Siège rembourré et dossier en métal*

Metal color shown  
Couleur de métal montrée : Sienna (58)



Back view / Vue arrière



49123-CO DSMB

**NON SWIVEL STOOL**

Distressed solid wood seat and metal backrest

**TABOURET NON PIVOTANT**

*Siège en bois massif usé et dossier en métal*

Metal and wood colors shown  
Couleurs de métal et de bois montrées : Harley (51)/Shady (84)



49123-CO USMB

**NON SWIVEL STOOL**

Upholstered seat and metal backrest

**TABOURET NON PIVOTANT**

*Siège rembourré et dossier en métal*

Metal color shown  
Couleur de métal montrée : Sienna (58)



39123-CO DSMB

**CHAIR**

Distressed solid wood seat and metal backrest

**CHAISE**

*Siège en bois massif usé et dossier en métal*

Metal and wood colors shown / Couleurs de métal et de bois montrées : Harley (51)/Shady (84)

**MEASUREMENTS / MESURES**

		W/L in/po	D/P in/po	H in/po	S in/po	A in/po	COM S* yd/vg	COM BR* yd/vg	W/P lb
<b>39123-CO</b>	<b>DSMB</b>	18	20 1/2	35 1/4	17 3/4	—	—	—	24.0
<b>39123-CO</b>	<b>USMB</b>	18	20 1/2	35 1/4	19 1/2	—	0.338	—	20.5
<b>49123-26CO</b>	<b>DSMB</b>	18	21	41 1/4	26 1/8	—	—	—	23.0
<b>49123-30CO</b>	<b>DSMB</b>	18	21	45 1/4	30 1/8	—	—	—	24.0
<b>49123-26CO</b>	<b>USMB</b>	18	21	41 1/4	27 1/2	—	0.338	—	18.5
<b>49123-30CO</b>	<b>USMB</b>	18	21	45 1/4	31 1/2	—	0.338	—	19.5

\* Refer to page 253 for accurate COM calculations / Référez-vous à la page 253 pour des calculs précis de COM



**NEW / NOUVEAU**

35211-CO USDB

**CHAIR**

Upholstered seat and metal backrest with distressed solid wood accent

**CHAISE**

*Siège rembourré et dossier en métal avec accent en bois massif usé*

Metal and wood colors shown  
Couleurs de métal et de bois montrées :  
Vanilla (68)/Stone dust (89)



**NEW / NOUVEAU**

41411-CO USDB

**SWIVEL STOOL**

(with memory return)

Upholstered seat and metal backrest with distressed solid wood accent

**TABOURET PIVOTANT**

(avec mécanisme à mémoire)

*Siège rembourré et dossier en métal avec accent en bois massif usé*

Metal and wood colors shown / Couleurs de métal et de bois montrées :  
Cobrizo (75)/Stone dust (89)



**NEW / NOUVEAU**

35411-CO USDB

**ARMCHAIR**

Upholstered seat and metal armrests and backrest with distressed solid wood accent

**CHAISE AVEC APPUIS-BRAS**

*Siège rembourré et appuis-bras et dossier en métal avec accent en bois massif usé*

Metal and wood colors shown  
Couleurs de métal et de bois montrées :  
Oxidado (52)/Toasty (87)

**MEASUREMENTS / MESURES**

		W/L in/po	D/P in/po	H in/po	S in/po	A in/po	COM S* yd/vg	COM BR* yd/vg	W/P lb
<b>35211-CO</b>	<b>USDB</b>	19 1/4	22 3/4	38 3/4	19 1/8	—	0.382	—	17
<b>35411-CO</b>	<b>USDB</b>	26	22 3/4	38 3/4	19	25 7/8	0.43	—	17
<b>41411-26CO</b>	<b>USDB</b>	19 1/4	21 1/4	45	26 7/8	—	0.329	—	23.5
<b>41411-30CO</b>	<b>USDB</b>	19 1/4	21 1/4	49	30 7/8	—	0.329	—	24.5
<b>41411-34CO</b>	<b>USDB</b>	19 1/4	22	53	34 5/8	—	0.329	—	25.5

\* Refer to page 253 for accurate COM calculations / Référez-vous à la page 253 pour des calculs précis de COM



# Cynthia



35211-CO USWB

**CHAIR**

Upholstered seat and metal backrest with solid wood accent

**CHAISE**

*Siège rembourré et dossier en métal avec accent en bois massif*

Metal and wood colors shown  
Couleurs de métal et de bois montrées :  
Cobrizo (75)/Porter (44)



35411-CO USWB

**ARMCHAIR**

Upholstered seat and metal armrests and backrest with solid wood accent

**CHAISE AVEC APPUIS-BRAS**

*Siège rembourré et appuis-bras et dossier en métal avec accent en bois massif*

Metal and wood colors shown  
Couleurs de métal et de bois montrées :  
Oxidado (52)/Rumcherry (41)



41411-CO USWB

**SWIVEL STOOL**

(with memory return)

Upholstered seat and metal backrest with solid wood accent

Metal and wood colors shown  
Couleurs de métal et de bois montrées :  
Cobrizo (75)/Porter (44)

**TABOURET PIVOTANT**

(avec mécanisme à mémoire)

*Siège rembourré et dossier en métal avec accent en bois massif*

**MEASUREMENTS / MESURES**

		W/L in/po	D/P in/po	H in/po	S in/po	A in/po	COM S* yd/vg	COM BR* yd/vg	W/P lb
<b>35211-CO</b>	<b>USWB</b>	19 1/4	22 3/4	38 3/4	19 1/8	—	0.382	—	17
<b>35411-CO</b>	<b>USWB</b>	26	22 3/4	38 3/4	19	25 7/8	0.43	—	17
<b>41411-26CO</b>	<b>USWB</b>	19 1/4	21 1/4	45	26 7/8	—	0.329	—	23.5
<b>41411-30CO</b>	<b>USWB</b>	19 1/4	21 1/4	49	30 7/8	—	0.329	—	24.5
<b>41411-34CO</b>	<b>USWB</b>	19 1/4	22	53	34 5/8	—	0.329	—	25.5

\* Refer to page 253 for accurate COM calculations / Référez-vous à la page 253 pour des calculs précis de COM



**NEW / NOUVEAU**

30574-CO USUB

**CHAIR**

Upholstered seat and backrest

**CHAISE**

*Siège et dossier rembourrés*

Metal color shown / Couleur de métal montrée : Titanium (56)



**NEW / NOUVEAU**

40574-CO USUB

**NON SWIVEL STOOL**

Upholstered seat and backrest

**TABOURET NON PIVOTANT**

*Siège et dossier rembourrés*

Metal color shown / Couleur de métal montrée : Titanium (56)

**MEASUREMENTS / MESURES**

		W/L in/po	D/P in/po	H in/po	S in/po	A in/po	COM S* yd/vg	COM BR* yd/vg	W/P lb
<b>30574-CO</b>	<b>USUB</b>	18 1/4	23 1/2	33 3/4	19	—	1.315	—	20
<b>40574-26CO</b>	<b>USUB</b>	18 1/4	23	42 1/2	27	—	1.315	—	23
<b>40574-30CO</b>	<b>USUB</b>	18 1/4	23	46 1/2	31	—	1.315	—	23.5

\* Refer to page 253 for accurate COM calculations / Référez-vous à la page 253 pour des calculs précis de COM

# Darlene



**NEW / NOUVEAU**

30573-CO USUB

**CHAIR**

Upholstered seat and backrest

**CHAISE**

*Siège et dossier rembourrés*

Metal color shown / Couleur de métal montrée : Titanium (56)



**NEW / NOUVEAU**

40573-CO USUB

**NON SWIVEL STOOL**

Upholstered seat and backrest

**TABOURET NON PIVOTANT**

*Siège et dossier rembourrés*

Metal color shown / Couleur de métal montrée : Titanium (56)

**MEASUREMENTS / MESURES**

		W/L in/po	D/P in/po	H in/po	S in/po	A in/po	COM S* yd/vg	COM BR* yd/vg	W/P lb
<b>30573-CO</b>	<b>USUB</b>	18 1/4	23 1/2	33 3/4	19	—	1.093	—	20
<b>40573-26CO</b>	<b>USUB</b>	18 1/4	23	42 1/2	27	—	1.093	—	23
<b>40573-30CO</b>	<b>USUB</b>	18 1/4	23	46 1/2	31	—	1.093	—	23.5

\* Refer to page 253 for accurate COM calculations / Référez-vous à la page 253 pour des calculs précis de COM



41443-CO USMB

**SWIVEL STOOL**  
(without memory return)

Upholstered seat  
and metal backrest

Metal color shown / Couleur de métal montrée : Magnétite (24)

**TABOURET PIVOTANT**  
(sans mécanisme à mémoire)

Siège rembourré  
et dossier en métal

## MEASUREMENTS / MESURES

		W/L	D/P	H	S	A	COM S*	COM BR*	W/P
		in/po	in/po	in/po	in/po	in/po	yd/vg	yd/vg	lb
<b>41443-26CO</b>	<b>USMB</b>	18 1/4	18 5/8	33 3/4	26 7/8	—	0.338	—	25
<b>41443-30CO</b>	<b>USMB</b>	18 1/4	18 5/8	37 3/4	30 7/8	—	0.338	—	26
<b>41443-34CO</b>	<b>USMB</b>	18 1/4	18 5/8	41 1/2	34 5/8	—	0.338	—	27

\* Refer to page 253 for accurate COM calculations / Référez-vous à la page 253 pour des calculs précis de COM



# Dexter



30223-CO USDB

**CHAIR**

Upholstered seat and distressed solid wood backrest

**CHAISE**

*Siège rembourré et dossier en bois massif usé*

Metal and wood colors shown  
Couleurs de métal et de bois montrées : Harley (51)/Sand dust (86)



30223-CO DSDB

**CHAIR**

Distressed solid wood seat and backrest

**CHAISE**

*Siège et dossier en bois massif usé*

Metal and wood colors shown  
Couleurs de métal et de bois montrées : Harley (51)/Sand dust (86)



40323-CO USDB

**NON SWIVEL STOOL**

Upholstered seat and distressed solid wood backrest

**TABOURET NON PIVOTANT**

*Siège rembourré et dossier en bois massif usé*

Metal and wood colors shown  
Couleurs de métal et de bois montrées : Harley (51)/Sand dust (86)



40323-CO DSDB

**NON SWIVEL STOOL**

Distressed solid wood seat and backrest

**TABOURET NON PIVOTANT**

*Siège et dossier en bois massif usé*

Metal and wood colors shown / Couleurs de métal et de bois montrées : Harley (51)/Sand dust (86)

**MEASUREMENTS / MESURES**

		W/L in/po	D/P in/po	H in/po	S in/po	A in/po	COM S* yd/vg	COM BR* yd/vg	W/P lb
30223-CO	DSDB	18 1/2	21 1/4	35 7/8	17 3/4	—	—	—	23
30223-CO	USDB	18 1/2	21 1/4	35 7/8	18 7/8	—	0.338	—	18.5
40323-26CO	DSDB	18 1/2	20 3/4	41 1/4	25	—	—	—	26
40323-30CO	DSDB	18 1/2	20 3/4	45 1/4	29	—	—	—	27
40323-26CO	USDB	18 1/2	20 3/4	41 1/4	26 3/8	—	0.338	—	23
40323-30CO	USDB	18 1/2	20 3/4	45 1/4	30 3/8	—	0.338	—	24

\* Refer to page 253 for accurate COM calculations / Référez-vous à la page 253 pour des calculs précis de COM



## 41540-CO USUB

### SWIVEL STOOL

(with memory return)

Upholstered seat  
and backrest

### TABOURET PIVOTANT

(avec mécanisme à mémoire)

Siège et dossier  
rembourrés

Metal color shown/ Couleur de métal montrée : Sun gold (27)

## MEASUREMENTS / MESURES

	W/L	D/P	H	S	A	COM S*	COM BR*	W/P
	in/po	in/po	in/po	in/po	in/po	yd/vg	yd/vg	lb
<b>41540-26CO USUB</b>	21	21 1/2	37	27 3/4	—	1.208	—	21
<b>41540-30CO USUB</b>	21	21 1/2	41	31 3/4	—	1.208	—	22

\* Refer to page 253 for accurate COM calculations / Référez-vous à la page 253 pour des calculs précis de COM



30535-CO USUB

**CHAIR**

Upholstered seat and backrest

**CHAISE**

Siège et dossier rembourrés

Metal color shown/ Couleur de métal montrée : Magnetite (24)



41535-CO USUB

**SWIVEL STOOL**

(without memory return)

Upholstered seat and backrest

**TABOURET PIVOTANT**

(sans mécanisme à mémoire)

Siège et dossier rembourrés

Metal color shown/ Couleur de métal montrée : Magnetite (24)

This design is now available as a non swivel stool. Please contact us for details and pricing. / Ce modèle est maintenant disponible en version non pivotante. Veuillez nous contacter pour les détails et les prix.

**MEASUREMENTS / MESURES**

		W/L in/ po	D/P in/ po	H in/ po	S in/ po	A in/ po	COM S* yd/ vg	COM BR* yd/ vg	W/P lb
<b>30535-CO</b>	<b>USUB</b>	22	20 3/4	31	18 7/8	—	0.389	0.641	24
<b>41535-26CO</b>	<b>USUB</b>	22	20 3/4	37 1/4	27	—	0.389	0.641	29.5
<b>41535-30CO</b>	<b>USUB</b>	22	20 3/4	41 1/4	31	—	0.389	0.641	30.5
<b>41535-34CO</b>	<b>USUB</b>	22	20 3/4	45 1/4	35	—	0.389	0.641	31.5

\* Refer to page 253 for accurate COM calculations/ Référez-vous à la page 253 pour des calculs précis de COM



35198-CO DSMB

**CHAIR**

Distressed solid wood seat and metal backrest

**CHAISE**

*Siège en bois massif usé et dossier en métal*

Metal and wood colors shown / *Couleurs de métal et de bois montrées* : Oxidado (52) / Toasty (87)



35198-CO USMB

**CHAIR**

Upholstered seat and metal backrest

**CHAISE**

*Siège rembourré et dossier en métal*

Metal color shown / *Couleur de métal montrée* : Oxidado (52)

**MEASUREMENTS / MESURES**

		W/L in./po	D/P in./po	H in./po	S in./po	A in./po	COM S* yd./vg	COM BR* yd./vg	W/P lb
35198-CO	DSMB	19 1/2	21 3/8	38	17 1/8	—	—	—	21.5
35198-CO	USMB	19 1/2	21 1/4	38	19 1/8	—	0.382	—	17.5

\* Refer to page 253 for accurate COM calculations / *Référez-vous à la page 253 pour des calculs précis de COM*



# Edwin



41498-CO DSMB

**SWIVEL STOOL**

(with memory return)

Distressed solid wood seat and metal backrest

**TABOURET PIVOTANT**

(avec mécanisme à mémoire)

Siège en bois massif usé et dossier en métal

Metal and wood colors shown  
Couleurs de métal et de bois montrées :  
Oxidado (52)/Toasty (87)



41498-CO USMB

**SWIVEL STOOL**

(with memory return)

Upholstered seat and metal backrest

**TABOURET PIVOTANT**

(avec mécanisme à mémoire)

Siège rembourré et dossier en métal

Metal color shown  
Couleur de métal montrée : -



49198-CO USMB

**NON SWIVEL STOOL**

Upholstered seat and metal backrest

**TABOURET NON PIVOTANT**

Siège rembourré et dossier en métal

Metal color shown  
Couleur de métal montrée : Metallo (57)



49198-CO DSMB

**NON SWIVEL STOOL**

Distressed solid wood seat and metal backrest

**TABOURET NON PIVOTANT**

Siège en bois massif usé et dossier en métal

Metal and wood colors shown/ Couleurs de métal et de bois montrées :  
Oxidado (52)/Toasty (87)

**MEASUREMENTS / MESURES**

		W/L	D/P	H	S	A	COM S*	COM BR*	W/P
		in/ po	in/ po	in/ po	in/ po	in/ po	yd/ vg	yd/ vg	lb
41498-26CO	DSMB	17 1/2	19 5/8	40 3/4	25 3/8	—	—	—	27.5
41498-30CO	DSMB	17 1/2	19 5/8	44 3/4	29 3/8	—	—	—	28.5
41498-34CO	DSMB	17 1/2	20 1/4	48 3/4	33 3/8	—	—	—	29.5
41498-26CO	USMB	17 1/2	19 5/8	40 3/4	26 3/4	—	0.329	—	25.5
41498-30CO	USMB	17 1/2	19 5/8	44 3/4	30 3/4	—	0.329	—	26.5
41498-34CO	USMB	17 1/2	20 1/4	48 3/4	34 5/8	—	0.329	—	27.5
49198-26CO	DSMB	19 1/2	21 5/8	40 7/8	24 1/8	—	—	—	26.5
49198-30CO	DSMB	19 1/2	21 5/8	44 7/8	28 1/8	—	—	—	27.5
49198-26CO	USMB	19 1/2	21 1/2	40 7/8	26 1/4	—	0.382	—	22.5
49198-30CO	USMB	19 1/2	21 1/2	44 7/8	30 1/4	—	0.382	—	23.5

\* Refer to page 253 for accurate COM calculations/ Référez-vous à la page 253 pour des calculs précis de COM



## 35210-CO USDB

### CHAIR

Upholstered seat and backrest with distressed solid wood accent

### CHAISE

*Siège et dossier rembourrés avec accent en bois massif usé*

Metal and wood colors shown  
Couleurs de métal et de bois montrées : Oxidado (52)/Sand dust (86)



## 35210-CO USWB

### CHAIR

Upholstered seat and backrest with solid wood accent

### CHAISE

*Siège et dossier rembourrés avec accent en bois massif*

Metal and wood colors shown  
Couleurs de métal et de bois montrées : Oxidado (52)/Rumcherry (41)



## 35410-CO USDB

### ARMCHAIR

Upholstered seat and backrest with metal armrests and distressed solid wood accent

### CHAISE AVEC APPUIS-BRAS

*Siège et dossier rembourrés avec appuis-bras en métal et accent en bois massif usé*

Metal and wood colors shown  
Couleurs de métal et de bois montrées : Oxidado (52)/Sand dust (86)



## 35410-CO USWB

### ARMCHAIR

Upholstered seat and backrest with metal armrests and solid wood accent

### CHAISE AVEC APPUIS-BRAS

*Siège et dossier rembourrés avec appuis-bras en métal et accent en bois massif*

Metal and wood colors shown/ Couleurs de métal et de bois montrées : Oxidado (52)/Rumcherry (41)

## MEASUREMENTS / MESURES

		W/L	D/P	H	S	A	COM S*	COM BR*	W/P
		in/po	in/po	in/po	in/po	in/po	yd/vg	yd/vg	lb
<b>35210-CO</b>	<b>USDB</b>	19 1/2	22 1/2	38	19 1/8	—	0.382	0.333	19.5
<b>35210-CO</b>	<b>USWB</b>	19 1/2	22 1/2	38	19 1/8	—	0.382	0.333	19.5
<b>35410-CO</b>	<b>USDB</b>	26	22 1/2	38	19 1/8	25 7/8	0.382	0.333	19.5
<b>35410-CO</b>	<b>USWB</b>	26	22 1/2	38	19 1/8	25 7/8	0.382	0.333	19.5

\* Refer to page 253 for accurate COM calculations / Référez-vous à la page 253 pour des calculs précis de COM

# Eleanor



41410-CO USDB

**SWIVEL STOOL**  
(with memory return)

Upholstered seat and backrest with distressed solid wood accent

Metal and wood colors shown / Couleurs de métal et de bois montrées : Metallo (57) / Sand dust (86)

**TABOURET PIVOTANT**  
(avec mécanisme à mémoire)

Siège et dossier rembourrés avec accent en bois massif usé



41410-CO USWB

**SWIVEL STOOL**  
(with memory return)

Upholstered seat and backrest with solid wood accent

Metal and wood colors shown / Couleurs de métal et de bois montrées : Metallo (57) / Rumcherry (41)

**TABOURET PIVOTANT**  
(avec mécanisme à mémoire)

Siège et dossier rembourrés avec accent en bois massif

## MEASUREMENTS / MESURES

		W/L in/po	D/P in/po	H in/po	S in/po	A in/po	COM S* yd/vg	COM BR* yd/vg	W/P lb
<b>41410-26CO</b>	<b>USDB</b>	18	20	44	26 5/8	—	0.329	0.44	27
<b>41410-30CO</b>	<b>USDB</b>	18	20	48	30 5/8	—	0.329	0.44	28
<b>41410-34CO</b>	<b>USDB</b>	18	21 1/2	52	34 5/8	—	0.329	0.44	30
<b>41410-26CO</b>	<b>USWB</b>	18	20	44	26 5/8	—	0.329	0.44	27
<b>41410-30CO</b>	<b>USWB</b>	18	20	48	30 5/8	—	0.329	0.44	28
<b>41410-34CO</b>	<b>USWB</b>	18	21 1/2	52	34 5/8	—	0.329	0.44	30

\* Refer to page 253 for accurate COM calculations / Référez-vous à la page 253 pour des calculs précis de COM



**NEW / NOUVEAU**

**44542-CO USUB**

**SWIVEL STOOL**

(without memory return)

Upholstered seat and backrest

**TABOURET PIVOTANT**

(sans mécanisme à mémoire)

Siège et dossier rembourrés

Metal color shown / Couleur de métal montrée : Black coral/Noir corail (25)

**MEASUREMENTS / MESURES**

		W/L in/po	D/P in/po	H in/po	S in/po	A in/po	COM S* yd/vg	COM BR* yd/vg	W/P lb
<b>44542-26CO</b>	<b>USUB</b>	21 3/4	19 5/8	34 5/8	27	—	0.315	0.519	28
<b>44542-30CO</b>	<b>USUB</b>	21 3/4	19 5/8	38 5/8	31	—	0.315	0.519	29

\* Refer to page 253 for accurate COM calculations / Référez-vous à la page 253 pour des calculs précis de COM

# Elmira



30530-CO USUB

**CHAIR**

Upholstered seat and backrest

**CHAISE**

*Siège et dossier rembourrés*

Metal color shown / Couleur de métal montrée : Magnetite (24)



41530-CO USUB

**SWIVEL STOOL**

(without memory return)

Upholstered seat and backrest

**TABOURET PIVOTANT**

*(sans mécanisme à mémoire)*

*Siège et dossier rembourrés*

Metal color shown / Couleur de métal montrée : Magnetite (24)

## MEASUREMENTS / MESURES

		W/L in/po	D/P in/po	H in/po	S in/po	A in/po	COM S* yd/vg	COM BR* yd/vg	W/P lb
<b>30530-CO</b>	<b>USUB</b>	18 1/2	21 1/4	36	18 1/2	—	0.981	—	18
<b>41530-26CO</b>	<b>USUB</b>	18 1/2	21 1/4	44 1/4	26 1/2	—	0.981	—	25.5
<b>41530-30CO</b>	<b>USUB</b>	18 1/2	21 1/4	48 1/4	30 1/2	—	0.981	—	26.5

\* Refer to page 253 for accurate COM calculations / Référez-vous à la page 253 pour des calculs précis de COM





49308-CO USUB

**NON SWIVEL STOOL**  
Upholstered seat  
and backrest

**TABOURET NON  
PIVOTANT**  
Siège et dossier rembourrés

Metal color shown / Couleur de métal montrée : Oxidado (52)



49309-CO USUB

**NON SWIVEL STOOL**  
Upholstered seat  
and backrest

**TABOURET NON  
PIVOTANT**  
Siège et dossier rembourrés

Metal color shown / Couleur de métal montrée : Metallo (57)

## MEASUREMENTS / MESURES

		W/L in/po	D/P in/po	H in/po	S in/po	A in/po	COM S* yd/vg	COM BR* yd/vg	W/P lb
<b>49308-26CO</b>	<b>USUB</b>	17 1/2	21 1/2	34	26 3/8	—	0.409	0.37	25
<b>49308-30CO</b>	<b>USUB</b>	17 1/2	21 1/2	38	30 3/8	—	0.409	0.37	26
<b>49309-26CO</b>	<b>USUB</b>	19 1/2	22 1/2	34	26 3/8	—	0.449	0.803	26.5
<b>49309-30CO</b>	<b>USUB</b>	19 1/2	22 1/2	38	30 3/8	—	0.449	0.803	27.5

\* Refer to page 253 for accurate COM calculations / Référez-vous à la page 253 pour des calculs précis de COM

## Fairfield

## Fairfield Plus



45314-CO USUB

**NON SWIVEL STOOL**

Upholstered seat  
and backrest

**TABOURET NON  
PIVOTANT**

*Siège et dossier rembourrés*

Metal color shown / Couleur de métal montrée : Magnetite (24)



45313-CO USUB

**NON SWIVEL STOOL**

Upholstered seat  
and backrest

**TABOURET NON  
PIVOTANT**

*Siège et dossier rembourrés*

Metal color shown / Couleur de métal montrée : Magnetite (24)

### MEASUREMENTS / MESURES

		W/L in/po	D/P in/po	H in/po	S in/po	A in/po	COM S* yd/vg	COM BR* yd/vg	W/P lb
<b>45313-26CO</b>	<b>USUB</b>	19 1/2	21 3/8	33 1/4	26 1/8	—	0.449	0.803	21.5
<b>45313-30CO</b>	<b>USUB</b>	19 1/2	21 3/8	37 1/4	30 1/8	—	0.449	0.803	22.5
<b>45314-26CO</b>	<b>USUB</b>	17 1/2	20 1/2	33 1/4	26 1/8	—	0.409	0.803	21
<b>45314-30CO</b>	<b>USUB</b>	17 1/2	20 1/2	37 1/4	30 1/8	—	0.409	0.803	22

\* Refer to page 253 for accurate COM calculations / Référez-vous à la page 253 pour des calculs précis de COM



41488-CO USMB

**SWIVEL STOOL**  
(without memory return)

Upholstered seat and  
metal backrest

Metal color shown/ Couleur de métal montrée : Mineral (73)

**TABOURET PIVOTANT**  
(sans mécanisme à mémoire)

Siège rembourré et dossier  
en métal

## MEASUREMENTS / MESURES

		W/L	D/P	H	S	A	COM S*	COM BR*	W/P
		in/ po	in/ po	in/ po	in/ po	in/ po	yd/ vg	yd/ vg	lb
<b>41488-26CO</b>	<b>USMB</b>	17 3/4	19 1/4	42 3/4	27 3/4	—	0.329	—	21
<b>41488-30CO</b>	<b>USMB</b>	17 3/4	19 1/4	46 3/4	31 3/4	—	0.329	—	22
<b>41488-34CO</b>	<b>USMB</b>	17 3/4	19 1/4	49 3/4	34 3/4	—	0.329	—	23

\* Refer to page 253 for accurate COM calculations/ Référez-vous à la page 253 pour des calculs précis de COM

# Gatlin



40491-CO DSMB

**SWIVEL STOOL**

(without memory return)

Distressed solid wood seat and metal backrest

Metal and wood colors shown/ Couleurs de métal et de bois montrées : Harley (51)/Toasty (87)

**TABOURET PIVOTANT**

(sans mécanisme à mémoire)

Siège en bois massif usé et dossier en métal



40491-CO USMB

**SWIVEL STOOL**

(without memory return)

Upholstered seat and metal backrest

Metal color shown/ Couleur de métal montrée : Harley (51)

**TABOURET PIVOTANT**

(sans mécanisme à mémoire)

Siège rembourré et dossier en métal

**MEASUREMENTS / MESURES**

		W/L in/ po	D/P in/ po	H in/ po	S in/ po	A in/ po	COM S* yd/ vg	COM BR* yd/ vg	W/P lb
40491-26CO	DSMB	22 3/4	22 5/8	37 1/8	25 1/4	32 1/8	—	—	28.5
40491-30CO	DSMB	22 3/4	22 5/8	42 1/4	30 3/8	36	—	—	29.5
40491-26CO	USMB	22 3/4	22 5/8	37 1/8	26 5/8	33 1/8	0.329	—	24.5
40491-30CO	USMB	22 3/4	22 5/8	41 1/4	30 1/2	36	0.329	—	25.5

\* Refer to page 253 for accurate COM calculations/ Référez-vous à la page 253 pour des calculs précis de COM



42414-CO DSNB

**SWIVEL STOOL**

(without memory return)

Distressed solid wood seat

**TABOURET PIVOTANT**

(sans mécanisme à mémoire)

Siège en bois massif usé

Metal and wood colors shown / Couleurs de métal et de bois montrées : Oxidado (52)/Toasty (87)



42414-CO USNB

**SWIVEL STOOL**

(without memory return)

Upholstered seat

**TABOURET PIVOTANT**

(sans mécanisme à mémoire)

Siège rembourré

Metal color shown / Couleur de métal montrée : Oxidado (52)

## MEASUREMENTS / MESURES

		W/L in/po	D/P in/po	H in/po	S in/po	A in/po	COM S* yd/vg	COM BR* yd/vg	W/P lb
<b>42414-26CO</b>	<b>DSNB</b>	16 1/8	16 1/8	26	26	—	—	—	24
<b>42414-30CO</b>	<b>DSNB</b>	17 1/8	17 1/8	30	30	—	—	—	25
<b>42414-34CO</b>	<b>DSNB</b>	18 1/8	18 1/8	34	34	—	—	—	26
<b>42414-26CO</b>	<b>USNB</b>	16 1/8	16 1/8	27 3/8	27 3/8	—	0.308	—	22
<b>42414-30CO</b>	<b>USNB</b>	17 1/8	17 1/8	31 3/8	31 3/8	—	0.308	—	23
<b>42414-34CO</b>	<b>USNB</b>	18 1/8	18 1/8	35 1/8	35 1/8	—	0.308	—	24

\* Refer to page 253 for accurate COM calculations / Référez-vous à la page 253 pour des calculs précis de COM



## Grissom

## Grissom Plus



### Grissom

30560-CO USUB

#### CHAIR

Upholstered seat and backrest

#### CHAISE

Siège et dossier rembourrés

Metal color shown  
Couleur de métal montrée :  
Black coral / Noir corail (25)



### Grissom Plus

30561-CO USUB

#### CHAIR

Upholstered seat and backrest

#### CHAISE

Siège et dossier rembourrés

Metal color shown  
Couleur de métal montrée :  
Black coral / Noir corail (25)



### Grissom

41560-CO USUB

#### SWIVEL STOOL (without memory return)

Upholstered seat  
and backrest

Metal color shown / Couleur de métal montrée : Black coral / Noir corail (25)

#### TABOURET PIVOTANT (sans mécanisme à mémoire)

Siège et dossier  
rembourrés

### MEASUREMENTS / MESURES

		W/L in/po	D/P in/po	H in/po	S in/po	A in/po	COM S* yd/vg	COM BR* yd/vg	W/P lb
<b>30560-CO</b>	<b>USUB</b>	22	25 1/4	34	20 7/8	29 3/4	0.418	0.972	26
<b>30561-CO</b>	<b>USUB</b>	24	25 1/4	34	20 7/8	29 3/4	0.48	1.106	28
<b>41560-26CO</b>	<b>USUB</b>	22	23 1/4	40 3/4	27 5/8	37 1/4	0.418	0.972	30.5
<b>41560-30CO</b>	<b>USUB</b>	22	23 1/4	44 3/4	31 5/8	41 1/4	0.418	0.972	31.5

\* Refer to page 253 for accurate COM calculations / Référez-vous à la page 253 pour des calculs précis de COM



**NEW / NOUVEAU**

44661-CO DSDB

**SWIVEL STOOL**

(without memory return)

Distressed solid wood seat and backrest

**TABOURET PIVOTANT**

(sans mécanisme à mémoire)

Siège et dossier en bois massif usé

Metal and wood colors shown / Couleur de métal et de bois montrées : Harley (51) / Toasty (87)



**NEW / NOUVEAU**

44661-CO USDB

**SWIVEL STOOL**

(without memory return)

Upholstered seat and distressed solid wood backrest

**TABOURET PIVOTANT**

(sans mécanisme à mémoire)

Siège rembourré et dossier en bois massif usé

Metal and wood colors shown / Couleur de métal et de bois montrées : Harley (51) / Toasty (87)

**MEASUREMENTS / MESURES**

		W/L in/po	D/P in/po	H in/po	S in/po	A in/po	COM S* yd/vg	COM BR* yd/vg	W/P lb
<b>44661-26CO</b>	<b>DSDB</b>	17 3/4	20 7/8	40 1/4	25 1/4	—	—	—	29
<b>44661-30CO</b>	<b>DSDB</b>	17 3/4	20 7/8	44 1/4	29 1/4	—	—	—	30
<b>44661-26CO</b>	<b>USDB</b>	17 3/4	20 7/8	40 1/4	26 1/2	—	0.329	—	25.5
<b>44661-30CO</b>	<b>USDB</b>	17 3/4	20 7/8	44 1/4	30 1/2	—	0.329	—	26.5

\* Refer to page 253 for accurate COM calculations / Référez-vous à la page 253 pour des calculs précis de COM

## Hanson

## Hanson Plus



45409-CO USUB

**NON SWIVEL STOOL**  
Upholstered seat  
and backrest

**TABOURET NON  
PIVOTANT**  
Siège et dossier rembourrés

Metal color shown / Couleur de métal montrée : Cobrizo (75)



45405-CO USUB

**NON SWIVEL STOOL**  
Upholstered seat  
and backrest

**TABOURET NON  
PIVOTANT**  
Siège et dossier rembourrés

Metal color shown / Couleur de métal montrée : Cobrizo (75)

### MEASUREMENTS / MESURES

	W/L in/po	D/P in/po	H in/po	S in/po	A in/po	COM S* yd/vg	COM BR* yd/vg	W/P lb
<b>45405-26CO USUB</b>	19 1/2	22 1/2	34 1/4	27	—	0.449	0.803	21.5
<b>45405-30CO USUB</b>	19 1/2	22 1/2	38 1/4	31	—	0.449	0.803	22.5
<b>45409-26CO USUB</b>	17 1/2	21 1/2	34 1/4	27	—	0.409	0.37	19.5
<b>45409-30CO USUB</b>	17 1/2	21 1/2	38 1/4	31	—	0.409	0.37	20.5

\* Refer to page 253 for accurate COM calculations / Référez-vous à la page 253 pour des calculs précis de COM



**NEW / NOUVEAU**

**44573-CO USUB**

**SWIVEL STOOL**  
(without memory return)

Upholstered seat and  
backrest

Metal color shown / Couleur de métal montrée : Cobrizo (75)

**TABOURET PIVOTANT**  
(sans mécanisme à mémoire)

Siège et dossier  
rembourrés

## MEASUREMENTS / MESURES

		W/L in/po	D/P in/po	H in/po	S in/po	A in/po	COM S* yd/vg	COM BR* yd/vg	W/P lb
<b>44573-26CO</b>	<b>USUB</b>	18 1/4	23 1/2	41 7/8	26 5/8	—	1.093	—	23
<b>44573-30CO</b>	<b>USUB</b>	18 1/4	23 1/2	45 7/8	30 5/8	—	1.093	—	24

\* Refer to page 253 for accurate COM calculations / Référez-vous à la page 253 pour des calculs précis de COM

# Hint



39202-CO USWB

**CHAIR**

Upholstered seat and wood veneer backrest (birch)

Metal and wood colors shown/ Couleurs de métal et de bois montrées : Oxidado (52)/Tiramisu (47)

**CHaise**

Siège rembourré et dossier en placage de bois (merisier)



40202-CO USWB

**NON SWIVEL STOOL**

Upholstered seat and wood veneer backrest (birch)

Metal and wood colors shown/ Couleurs de métal et de bois montrées : Oxidado (52)/Tiramisu (47)

**TABOURET NON PIVOTANT**

Siège rembourré et dossier en placage de bois (merisier)

## MEASUREMENTS / MESURES

		W/L	D/P	H	S	A	COM S*	COM BR*	W/P
		in/ po	in/ po	in/ po	in/ po	in/ po	yd/ vg	yd/ vg	lb
<b>39202-CO</b>	<b>USWB</b>	17 1/2	19 1/2	31 3/4	18 7/8	—	0.3199	—	12.5
<b>40202-26CO</b>	<b>USWB</b>	17 1/2	20 1/4	37 1/2	26 1/2	—	0.3199	—	15.5
<b>40202-30CO</b>	<b>USWB</b>	17 1/2	20 1/4	41 1/2	30 1/2	—	0.3199	—	16.5

\* Refer to page 253 for accurate COM calculations/ Référez-vous à la page 253 pour des calculs précis de COM





Backless version available  
See Phyllo on page 146  
*Version sans dossier disponible*  
*Voir Phyllo à la page 146*

41402-CO USWB

**SWIVEL STOOL**

(with memory return)

Upholstered seat and metal backrest with solid wood accent

**TABOURET PIVOTANT**

(avec mécanisme à mémoire)

*Siège rembourré et dossier en métal avec accent en bois massif*

Metal and wood colors shown / *Couleurs de métal et de bois montrées* : - / -

**MEASUREMENTS / MESURES**

		W/L in/po	D/P in/po	H in/po	S in/po	A in/po	COM S* yd/vg	COM BR* yd/vg	W/P lb
<b>41402-26CO</b>	<b>USWB</b>	17	20 3/8	36 5/8	26 1/8	—	0.308	—	27.5
<b>41402-30CO</b>	<b>USWB</b>	17	20 3/8	40 5/8	30 1/8	—	0.308	—	28.5

\* Refer to page 253 for accurate COM calculations / *Référez-vous à la page 253 pour des calculs précis de COM*



**NEW / NOUVEAU**

34572-CO USUB

**CHAIR**

Upholstered seat and backrest

**CHAISE**

*Siège et dossier rembourrés*

Metal color shown / Couleur de métal montrée : Black coral / Noir corail (25)



**NEW / NOUVEAU**

44572-CO USUB

**SWIVEL STOOL**

(without memory return)

Upholstered seat and backrest

**TABOURET PIVOTANT**

*(sans mécanisme à mémoire)*

*Siège et dossier rembourrés*

Metal color shown / Couleur de métal montrée : Black coral / Noir corail (25)

## MEASUREMENTS / MESURES

		W/L in/po	D/P in/po	H in/po	S in/po	A in/po	COM S* yd/vg	COM BR* yd/vg	W/P lb
<b>34572-CO</b>	<b>USUB</b>	20 1/2	22 1/4	35	18 5/8	—	0.338	0.223	16.50
<b>44572-26CO</b>	<b>USUB</b>	17	20	37	26 7/8	—	0.336	0.147	22
<b>44572-30CO</b>	<b>USUB</b>	17	20	41	30 7/8	—	0.336	0.147	23

\* Refer to page 253 for accurate COM calculations / Référez-vous à la page 253 pour des calculs précis de COM



Back view / Vue arrière

## 41527-CO DSMB

### SWIVEL STOOL

(without memory return)

Distressed solid wood seat and metal backrest

Metal and wood colors shown / Couleurs de métal et de bois montrées : Harley (51) / Toasty (87)

### TABOURET PIVOTANT

(sans mécanisme à mémoire)

Siège en bois massif usé et dossier en métal

## 41527-CO USMB

### SWIVEL STOOL

(without memory return)

Upholstered seat and metal backrest

Metal color shown / Couleur de métal montrée : Harley (51)

### TABOURET PIVOTANT

(sans mécanisme à mémoire)

Siège rembourré et dossier en métal

## MEASUREMENTS / MESURES

		W/L in/po	D/P in/po	H in/po	S in/po	A in/po	COM S* yd/vg	COM BR* yd/vg	W/P lb
<b>41527-26CO</b>	<b>DSMB</b>	17 3/4	20 1/2	39 1/2	25 1/4	—	—	—	29
<b>41527-30CO</b>	<b>DSMB</b>	17 3/4	20 1/2	43 1/2	29 1/4	—	—	—	30.5
<b>41527-26CO</b>	<b>USMB</b>	17 3/4	20 1/2	39 1/2	26 1/2	—	0.329	—	25.5
<b>41527-30CO</b>	<b>USMB</b>	17 3/4	20 1/2	43 1/2	30 1/2	—	0.329	—	27

\* Refer to page 253 for accurate COM calculations / Référez-vous à la page 253 pour des calculs précis de COM



**NEW / NOUVEAU**

41567-CO DSDB

**SWIVEL STOOL**

(without memory return)

Distressed solid wood seat and backrest

Metal and wood colors shown/ Couleur de métal et de bois montrées : Harley (51)/ Toasty (87)

**TABOURET PIVOTANT**

(sans mécanisme à mémoire)

Siège et dossier en bois massif usé



**NEW / NOUVEAU**

41567-CO USDB

**SWIVEL STOOL**

(without memory return)

Upholstered seat and distressed solid wood backrest

Metal and wood colors shown/ Couleur de métal et de bois montrées : Harley (51)/ Toasty (87)

**TABOURET PIVOTANT**

(sans mécanisme à mémoire)

Siège rembourré et dossier en bois massif usé

**MEASUREMENTS / MESURES**

		W/L in/po	D/P in/po	H in/po	S in/po	A in/po	COM S* yd/vg	COM BR* yd/vg	W/P lb
<b>41567-26-CO</b>	<b>DSDB</b>	17 3/4	20 7/8	38 3/4	25 1/4	—	—	—	28
<b>41567-30CO</b>	<b>DSDB</b>	17 3/4	20 7/8	42 3/4	29 1/4	—	—	—	26.50
<b>41567-26CO</b>	<b>USDB</b>	17 3/4	20 7/8	38 3/4	26 1/2	—	0.329	—	25
<b>41567-30CO</b>	<b>USDB</b>	17 3/4	20 7/8	42 3/4	30 1/2	—	0.329	—	23.50

\* Refer to page 253 for accurate COM calculations/ Référez-vous à la page 253 pour des calculs précis de COM



Back view / Vue arrière



**Joan**

30237-CO USUB

**ARMCHAIR**

Upholstered seat, backrest and armrests

**CHAISE AVEC APPUIS-BRAS**

*Siège, dossier et appuis-bras rembourrés*

Metal color shown  
Couleur de métal montrée : Cobrizo (75)



Back view / Vue arrière



**Jonas**

30137-CO USUB

**ARMCHAIR**

Upholstered seat, backrest and armrests

**CHAISE AVEC APPUIS-BRAS**

*Siège, dossier et appuis-bras rembourrés*

Metal color shown  
Couleur de métal montrée : Sienna (58)



**Jonas**

41437-CO USUB

**SWIVEL STOOL**

(without memory return)

Upholstered seat and backrest with metal armrests

Metal color shown / Couleur de métal montrée : -

**TABOURET PIVOTANT**

(sans mécanisme à mémoire)

*Siège et dossier rembourrés avec appuis-bras en métal*

**MEASUREMENTS / MESURES**

		W/L in/po	D/P in/po	H in/po	S in/po	A in/po	COM S* yd/vg	COM BR* yd/vg	COM A* yd/vg	W/P lb
<b>30137-CO</b>	<b>USUB</b>	24	23	32	18 3/8	24	0.495	0.382	0.053	24.5
<b>30237-CO</b>	<b>USUB</b>	24	23 1/2	32	18 3/8	24	0.495	0.382	0.053	26
<b>41437-26CO</b>	<b>USUB</b>	24	22 3/4	41	27 1/8	32 1/2	0.495	0.382	—	27.5
<b>41437-30CO</b>	<b>USUB</b>	24	22 3/4	45	31 1/8	36 1/2	0.495	0.382	—	28.5

\* Refer to page 253 for accurate COM calculations / Référez-vous à la page 253 pour des calculs précis de COM



# Kent



Back view / Vue arrière



## 41528-CO DSMB

### SWIVEL STOOL

(without memory return)

Distressed solid wood seat and metal backrest

### TABOURET PIVOTANT

(sans mécanisme à mémoire)

Siège en bois massif usé et dossier en métal

Metal and wood colors shown / Couleurs de métal et de bois montrées : Black coral / Noir corail (25) / Stone dust (89)

## 41528-CO USMB

### SWIVEL STOOL

(without memory return)

Upholstered seat and metal backrest

### TABOURET PIVOTANT

(sans mécanisme à mémoire)

Siège rembourré et dossier en métal

Metal color shown / Couleur de métal montrée : Black coral / Noir corail (25)

## MEASUREMENTS / MESURES

		W/L in/po	D/P in/po	H in/po	S in/po	A in/po	COM S* yd/vg	COM BR* yd/vg	W/P lb
41528-26CO	DSMB	17 3/4	21 5/8	42 1/4	25 1/4	—	—	—	31.5
41528-30CO	DSMB	17 3/4	21 5/8	46 1/4	29 1/4	—	—	—	33
41528-26CO	USMB	17 3/4	21 5/8	42 1/4	26 5/8	—	0.329	—	28
41528-30CO	USMB	17 3/4	21 5/8	46 1/4	30 5/8	—	0.329	—	29.5

\* Refer to page 253 for accurate COM calculations / Référez-vous à la page 253 pour des calculs précis de COM



40494-CO USUB

**SWIVEL STOOL**

(without memory return)

Upholstered seat and backrest with metal armrests

Metal color shown/ Couleur de métal montrée : Metallo (57)

**TABOURET PIVOTANT**

(sans mécanisme à mémoire)

Siège et dossier rembourrés avec appuis-bras en métal

**MEASUREMENTS / MESURES**

	W/L	D/P	H	S	A	COM S*	COM BR*	W/P
	in/po	in/po	in/po	in/po	in/po	yd/vg	yd/vg	lb
<b>40494-24CO USUB</b>	21 3/8	23 1/2	36 1/4	25 1/2	31 1/8	0.326	0.132	29.5
<b>40494-30CO USUB</b>	21 3/8	23 1/2	42 1/4	31 1/8	36 7/8	0.326	0.132	31
<b>40494-34CO USUB</b>	21 3/8	23 1/2	45	34 3/8	39 5/8	0.326	0.132	32

\* Refer to page 253 for accurate COM calculations / Référez-vous à la page 253 pour des calculs précis de COM



## 35214-CO DSDB

### CHAIR

Distressed solid wood seat and accent with metal backrest

### CHAISE

*Siège et accent en bois massif usé avec dossier en métal*

Metal and wood colors shown  
Couleurs de métal et de bois montrées : Oxidado (52)/Toasty (87)



## 35214-CO USWB

### CHAIR

Upholstered seat and metal backrest with solid wood accent

### CHAISE

*Siège rembourré et dossier en métal avec accent en bois massif*

Metal and wood colors shown / Couleurs de métal et de bois montrées : Oxidado (52) / -



## 35214-CO USDB

### CHAIR

Upholstered seat and metal backrest with distressed solid wood accent

### CHAISE

*Siège rembourré et dossier en métal avec accent en bois massif usé*

Metal and wood colors shown  
Couleurs de métal et de bois montrées : Oxidado (52)/Toasty (87)

## MEASUREMENTS / MESURES

		W/L in/po	D/P in/po	H in/po	S in/po	A in/po	COM S* yd/vg	COM BR* yd/vg	W/P lb
35214-CO	DSDB	19 1/2	22 3/8	38	17 1/8	—	—	—	21.5
35214-CO	USDB	19 1/2	22 1/4	38	19 1/8	—	0.382	—	17.5
35214-CO	USWB	19 1/2	22 1/4	38	19 1/8	—	0.382	—	17.5

\* Refer to page 253 for accurate COM calculations / Référez-vous à la page 253 pour des calculs précis de COM



35414-CO USDB

**ARMCHAIR**

Upholstered seat and metal armrests and backrest with distressed solid wood accent

**CHAISE AVEC APPUIS-BRAS**

*Siège rembourré et appuis-bras et dossier en métal avec accent en bois massif usé*

Metal and wood colors shown / Couleurs de métal et de bois montrées : Sienna (58)/Toasty (87)

35414-CO USWB

**ARMCHAIR**

Upholstered seat and metal armrests and backrest with solid wood accent

**CHAISE AVEC APPUIS-BRAS**

*Siège rembourré et appuis-bras et dossier en métal avec accent en bois massif*

Metal and wood colors shown / Couleurs de métal et de bois montrées : Sienna (58)/Rumcherry (41)

**MEASUREMENTS / MESURES**

		W/L in/po	D/P in/po	H in/po	S in/po	A in/po	COM S* yd/vg	COM BR* yd/vg	W/P lb
<b>35414-CO</b>	<b>USDB</b>	26	22 1/4	38 3/4	19	25 7/8	0.382	—	17.5
<b>35414-CO</b>	<b>USWB</b>	26	22 1/4	38 3/4	19	25 7/8	0.382	—	17.5

\* Refer to page 253 for accurate COM calculations / Référez-vous à la page 253 pour des calculs précis de COM

# Kyle



## 41414-CO USDB

### SWIVEL STOOL

(with memory return)

Upholstered seat and metal backrest with distressed solid wood accent

### TABOURET PIVOTANT

(avec mécanisme à mémoire)

Siège rembourré et dossier en métal avec accent en bois massif usé

Metal and wood colors shown  
Couleurs de métal et de bois montrées :  
Oxidado (52)/Toasty (87)



## 41414-CO DSDB

### SWIVEL STOOL

(with memory return)

Distressed solid wood seat and accent with metal backrest

### TABOURET PIVOTANT

(avec mécanisme à mémoire)

Siège et accent en bois massif usé avec dossier en métal

Metal and wood colors shown / Couleurs de métal et de bois montrées :  
Oxidado (52)/Toasty (87)



## 41414-CO USWB

### SWIVEL STOOL

(with memory return)

Upholstered seat and metal backrest with solid wood accent

### TABOURET PIVOTANT

(avec mécanisme à mémoire)

Siège rembourré et dossier en métal avec accent en bois massif

Metal and wood colors shown  
Couleurs de métal et de bois montrées :  
Oxidado (52)/Porter (44)

## MEASUREMENTS / MESURES

		W/L in / po	D/P in / po	H in / po	S in / po	A in / po	COM S* yd / vg	COM BR* yd / vg	W/P lb
41414-26CO	DSDB	17 1/2	21	43 5/8	25 1/2	—	—	—	28.5
41414-30CO	DSDB	17 1/2	21	47 5/8	29 1/2	—	—	—	29.5
41414-34CO	DSDB	17 1/2	21 1/2	52 1/4	33 1/4	—	—	—	30.5
41414-26CO	USDB	17 1/2	21	43 5/8	26 7/8	—	0.329	—	25.5
41414-30CO	USDB	17 1/2	21	47 5/8	30 7/8	—	0.329	—	26.5
41414-34CO	USDB	17 1/2	21 1/2	52 1/4	34 5/8	—	0.329	—	27.5
41414-26CO	USWB	17 1/2	21	43 5/8	26 7/8	—	0.329	—	25.5
41414-30CO	USWB	17 1/2	21	47 5/8	30 7/8	—	0.329	—	26.5
41414-34CO	USWB	17 1/2	21 1/2	52 1/4	34 5/8	—	0.329	—	27.5

\* Refer to page 253 for accurate COM calculations / Référez-vous à la page 253 pour des calculs précis de COM





## 49224-CO USDB

### NON SWIVEL STOOL

Upholstered seat and metal backrest with distressed solid wood accent

### TABOURET NON PIVOTANT

*Siège rembourré et dossier en métal avec accent en bois massif usé*

Metal and wood colors shown  
Couleurs de métal et de bois montrées :  
Metallo (57)/Toasty (87)



## 49224-CO DSDB

### NON SWIVEL STOOL

Distressed solid wood seat and accent with metal backrest

### TABOURET NON PIVOTANT

*Siège et accent en bois massif usé avec dossier en métal*

Metal and wood colors shown/ Couleurs de métal et de bois montrées :  
Oxidado (52)/Toasty (87)



## 49224-CO USWB

### NON SWIVEL STOOL

Upholstered seat and metal backrest with solid wood accent

### TABOURET NON PIVOTANT

*Siège rembourré et dossier en métal avec accent en bois massif*

Metal and wood colors shown  
Couleurs de métal et de bois montrées :  
Metallo (57)/Porter (44)

## MEASUREMENTS / MESURES

		W/L	D/P	H	S	A	COM S*	COM BR*	W/P
		in/po	in/po	in/po	in/po	in/po	yd/vg	yd/vg	lb
49224-26CO	DSDB	19 1/2	22 5/8	41 1/4	24 1/8	—	—	—	26.5
49224-30CO	DSDB	19 1/2	22 5/8	45 1/4	28 1/8	—	—	—	27.5
49224-26CO	USDB	19 1/2	22 1/2	41 1/4	26 1/4	—	0.382	—	22.5
49224-30CO	USDB	19 1/2	22 1/2	45 1/4	30 1/4	—	0.382	—	23.5
49224-26CO	USWB	19 1/2	22 1/2	41 1/4	26 1/4	—	0.382	—	22.5
49224-30CO	USWB	19 1/2	22 1/2	45 1/4	30 1/4	—	0.382	—	23.5

\* Refer to page 253 for accurate COM calculations / Référez-vous à la page 253 pour des calculs précis de COM

# Larkin



**NEW / NOUVEAU**

**44570-CO USMB**

**SWIVEL STOOL**  
(without memory return)

Upholstered seat and  
metal backrest

**TABOURET PIVOTANT**  
(sans mécanisme à mémoire)

Siège rembourré et dossier  
en métal

Metal color shown / Couleur de métal montrée : Black coral / Noir corail (25)

## MEASUREMENTS / MESURES

		W/L in/po	D/P in/po	H in/po	S in/po	A in/po	COM S* yd/vg	COM BR* yd/vg	W/P lb
<b>44570-26CO</b>	<b>USMB</b>	18 1/4	18 5/8	38 3/4	26 1/8	—	0.338	—	23
<b>44570-30CO</b>	<b>USMB</b>	18 1/4	18 5/8	42 3/4	30 1/8	—	0.338	—	24

\* Refer to page 253 for accurate COM calculations / Référez-vous à la page 253 pour des calculs précis de COM



## 30593-CO DSMB

### CHAIR

Distressed solid wood seat and metal backrest

### CHAISE

*Siège en bois massif usé et dossier en métal*

Metal and wood colors shown  
*Couleurs de métal et de bois montrées : Harley (51)/Shady (84)*



Backless version available  
See Connor on page 86  
*Version sans dossier disponible Voir Connor à la page 86*



## 30593-CO USMB

### CHAIR

Upholstered seat and metal backrest

### CHAISE

*Siège rembourré et dossier en métal*

Metal color shown  
*Couleur de métal montrée : Harley (51)*



## 40593-CO USMB

### SWIVEL STOOL

(without memory return)

Upholstered seat and metal backrest

### TABOURET PIVOTANT

*(sans mécanisme à mémoire)*

*Siège rembourré et dossier en métal*

Metal color shown  
*Couleur de métal montrée : Harley (51)*

This design is now available as a non swivel stool. Please contact us for details and pricing.  
*Ce modèle est maintenant disponible en version non pivotante. Veuillez nous contacter pour les détails et les prix.*



## 40593-CO DSMB

### SWIVEL STOOL

(without memory return)

Distressed solid wood seat and metal backrest

Metal and wood colors shown/*Couleurs de métal et de bois montrées : Harley (51)/Toasty (87)*

This design is now available as a non swivel stool. Please contact us for details and pricing.  
*Ce modèle est maintenant disponible en version non pivotante. Veuillez nous contacter pour les détails et les prix.*

### TABOURET PIVOTANT

*(sans mécanisme à mémoire)*

*Siège en bois massif usé et dossier en métal*

## MEASUREMENTS / MESURES

		W/L	D/P	H	S	A	COM S*	COM BR*	W/P
		in/pt	in/pt	in/pt	in/pt	in/pt	yd/vg	yd/vg	lb
30593-CO	DSMB	17 3/4	19 3/8	31	17 3/4	—	—	—	18
30593-CO	USMB	17 3/4	19 3/8	31	19 1/2	—	0.329	—	15
40593-26CO	DSMB	17 1/2	19 1/2	35 1/2	25 1/2	—	—	—	29
40593-30CO	DSMB	17 1/2	19 1/2	39 1/2	29 1/2	—	—	—	30
40593-34CO	DSMB	18 3/4	19 1/2	43 5/8	33 1/4	—	—	—	31.5
40593-26CO	USMB	17 1/2	19 1/2	35 1/2	26 3/8	—	0.347	—	25
40593-30CO	USMB	17 1/2	19 1/2	39 1/2	30 3/8	—	0.347	—	27
40593-34CO	USMB	18 3/4	19 1/2	43 5/8	34 1/8	—	0.347	—	28.5

\* Refer to page 253 for accurate COM calculations / *Référez-vous à la page 253 pour des calculs précis de COM*

# Madison



41406-CO USWB

**SWIVEL STOOL**

(with memory return)

Upholstered seat and metal backrest with wood veneer accent (birch)

**TABOURET PIVOTANT**

(avec mécanisme à mémoire)

Siège rembourré et dossier en métal avec accent en placage de bois (merisier)

Metal and wood colors shown / Couleurs de métal et de bois montrées : Oxidado (52) / Rumcherry (41)

**MEASUREMENTS / MESURES**

		W/L	D/P	H	S	A	COM S*	COM BR*	W/P
		in/po	in/po	in/po	in/po	in/po	yd/vg	yd/vg	lb
<b>41406-26CO</b>	<b>USWB</b>	17 1/2	20 1/4	40 1/4	26 7/8	—	0.329	—	25.5
<b>41406-30CO</b>	<b>USWB</b>	17 1/2	20 1/4	44 1/4	30 7/8	—	0.329	—	26.5
<b>41406-34CO</b>	<b>USWB</b>	18 3/4	21 1/4	48	34 5/8	—	0.329	—	28

\* Refer to page 253 for accurate COM calculations / Référez-vous à la page 253 pour des calculs précis de COM



39151-CO USMB

**CHAIR**

Upholstered seat  
and metal backrest

Metal color shown/ Couleur de métal montrée : Oxidado (52)

**CHAISE**

*Siège rembourré et  
dossier en métal*



41451-CO USMB

**SWIVEL STOOL**

(without memory return)

Upholstered seat and  
metal backrest

Metal color shown/ Couleur de métal montrée : Oxidado (52)

**TABOURET PIVOTANT**

(sans mécanisme à mémoire)

*Siège rembourré et dossier  
en métal*

**MEASUREMENTS / MESURES**

		W/L in/po	D/P in/po	H in/po	S in/po	A in/po	COM S* yd/vg	COM BR* yd/vg	W/P lb
<b>39151-CO</b>	<b>USMB</b>	17 1/2	21 1/2	34 1/4	19 3/8	—	0.329	—	14
<b>41451-26CO</b>	<b>USMB</b>	17 3/4	19 1/4	42 3/4	27 3/4	—	0.329	—	18.5
<b>41451-30CO</b>	<b>USMB</b>	17 3/4	19 1/4	46 3/4	31 3/4	—	0.329	—	19.5
<b>41451-34CO</b>	<b>USMB</b>	17 3/4	19 1/4	49 3/4	34 3/4	—	0.329	—	21.5

\* Refer to page 253 for accurate COM calculations/ Référez-vous à la page 253 pour des calculs précis de COM



# Meadow

Find Melrose on pages 131-132  
Voir Melrose aux pages 131-132



41466-CO USMB

**SWIVEL STOOL**  
(without memory return)

Upholstered seat and  
metal backrest

Metal color shown/ Couleur de métal montrée : Oxidado (52)

**TABOURET PIVOTANT**  
(sans mécanisme à mémoire)

Siège rembourré et dossier  
en métal

## MEASUREMENTS / MESURES

	W/L in/po	D/P in/po	H in/po	S in/po	A in/po	COM S* yd/vg	COM BR* yd/vg	W/P lb
<b>41466-26CO USMB</b>	17 3/4	19 1/4	41 7/8	27 1/8	—	0.329	—	18.5
<b>41466-30CO USMB</b>	17 3/4	19 1/4	46 1/2	31 3/4	—	0.329	—	19.5

\* Refer to page 253 for accurate COM calculations / Référez-vous à la page 253 pour des calculs précis de COM



**NEW / NOUVEAU**

**40035-CO USNB**

**NON SWIVEL STOOL**  
Upholstered seat

**TABOURET NON PIVOTANT**  
Siège rembourré

Metal color shown / Couleur de métal montrée : Oxidado (52)

## MEASUREMENTS / MESURES

	<b>W/L</b> in/ po	<b>D/P</b> in/ po	<b>H</b> in/ po	<b>S</b> in/ po	<b>A</b> in/ po	<b>COM S*</b> yd/ vg	<b>COM BR*</b> yd/ vg	<b>W/P</b> lb
<b>40035-26CO USNB</b>	20	14 3/4	26 3/4	26 3/4	—	0.424	—	17.5
<b>40035-30CO USNB</b>	20	14 3/4	30 3/4	30 3/4	—	0.424	—	19

\* Refer to page 253 for accurate COM calculations / Référez-vous à la page 253 pour des calculs précis de COM



41548-CO USUB

**SWIVEL STOOL**  
(with memory return)

Upholstered seat  
and backrest

**TABOURET PIVOTANT**  
(avec mécanisme à mémoire)

Siège et dossier  
rembourrés

Metal color shown / Couleur de métal montrée : Titanium (56)

## MEASUREMENTS / MESURES

		W/L in/po	D/P in/po	H in/po	S in/po	A in/po	COM S* yd/vg	COM BR* yd/vg	W/P lb
<b>41548-26CO</b>	<b>USUB</b>	21 1/2	21 1/2	36 1/2	27	—	1.168	—	19.5
<b>41548-30CO</b>	<b>USUB</b>	21 1/2	21 1/2	40 1/2	31	—	1.168	—	20.5

\* Refer to page 253 for accurate COM calculations / Référez-vous à la page 253 pour des calculs précis de COM



**Monroe**  
35404-CO USUB  
**CHAIR**  
Upholstered seat and backrest  
**CHAISE**  
*Siège et dossier rembourrés*  
Metal color shown  
*Couleur de métal montrée :*  
Titanium (56)



**Mitchell**  
35405-CO USUB  
**CHAIR**  
Upholstered seat and backrest  
**CHAISE**  
*Siège et dossier rembourrés*  
Metal color shown  
*Couleur de métal montrée :*  
Titanium (56)



**Melrose**  
35408-CO USUB  
**CHAIR**  
Upholstered seat and backrest  
**CHAISE**  
*Siège et dossier rembourrés*  
Metal color shown  
*Couleur de métal montrée :*  
Titanium (56)



**Marlon**  
35409-CO USUB  
**CHAIR**  
Upholstered seat and backrest  
**CHAISE**  
*Siège et dossier rembourrés*  
Metal color shown / *Couleur de métal montrée :* Titanium (56)

**MEASUREMENTS / MESURES**

		W/L	D/P	H	S	A	COM S*	COM BR*	W/P
		in/po	in/po	in/po	in/po	in/po	yd/vg	yd/vg	lb
<b>35404-CO</b>	<b>USUB</b>	19 1/2	24	33 1/4	18 3/4	—	0.449	0.646	19.5
<b>35405-CO</b>	<b>USUB</b>	19 1/2	26 1/4	40 1/4	18 3/4	—	0.449	0.801	19
<b>35408-CO</b>	<b>USUB</b>	17 1/2	22 1/2	33 1/2	18 3/4	—	0.409	0.495	18
<b>35409-CO</b>	<b>USUB</b>	17 1/2	23 1/2	38 1/2	18 3/4	—	0.409	0.678	16.5

\* Refer to page 253 for accurate COM calculations / *Référez-vous à la page 253 pour des calculs précis de COM*

# Melrose

# Monroe



45408-CO USUB

**NON SWIVEL STOOL**  
Upholstered seat and  
backrest

**TABOURET NON  
PIVOTANT**  
Siège et dossier rembourrés

Metal color shown / Couleur de métal montrée : Titanium (56)



45404-CO USUB

**NON SWIVEL STOOL**  
Upholstered seat and  
backrest

**TABOURET NON  
PIVOTANT**  
Siège et dossier rembourrés

Metal color shown / Couleur de métal montrée : Titanium (56)

## MEASUREMENTS / MESURES

	W/L in/po	D/P in/po	H in/po	S in/po	A in/po	COM S* yd/vg	COM BR* yd/vg	W/P lb
<b>45404-26CO USUB</b>	19 1/2	24	41 1/2	27	—	0.449	0.646	22.5
<b>45404-30CO USUB</b>	19 1/2	24	45 1/2	31	—	0.449	0.646	23.5
<b>45408-26CO USUB</b>	17 1/2	23	41 1/2	27	—	0.409	0.495	21
<b>45408-30CO USUB</b>	17 1/2	23	45 1/2	31	—	0.409	0.495	22

\* Refer to page 253 for accurate COM calculations / Référez-vous à la page 253 pour des calculs précis de COM





40033-CO USNB

**NON SWIVEL STOOL**

Upholstered seat

**TABOURET NON  
PIVOTANT**

*Siège rembourré*

Metal color shown/ Couleur de métal montrée : Oxidado (52)

## MEASUREMENTS / MESURES

	W/L in/po	D/P in/po	H in/po	S in/po	A in/po	COM S* yd/vg	COM BR* yd/vg	W/P lb
<b>40033-26CO USNB</b>	20 5/8	15 7/8	27 3/4	26 3/4	—	0.313	—	15
<b>40033-30CO USNB</b>	20 5/8	16 3/8	31 3/4	30 3/4	—	0.313	—	16

\* Refer to page 253 for accurate COM calculations / Référez-vous à la page 253 pour des calculs précis de COM

# Nest



41477-CO DSMB

**SWIVEL STOOL**

(without memory return)

Distressed solid wood seat and metal backrest

Metal and wood colors shown/ Couleurs de métal et de bois montrées : Cobrizo (75)/ Sand dust (86)

**TABOURET PIVOTANT**

(sans mécanisme à mémoire)

Siège en bois massif usé et dossier en métal



41477-CO USMB

**SWIVEL STOOL**

(without memory return)

Upholstered seat and metal backrest

Metal color shown/ Couleur de métal montrée : Cobrizo (75)

**TABOURET PIVOTANT**

(sans mécanisme à mémoire)

Siège rembourré et dossier en métal

**MEASUREMENTS / MESURES**

		W/L in/po	D/P in/po	H in/po	S in/po	A in/po	COM S* yd/vg	COM BR* yd/vg	W/P lb
<b>41477-26CO</b>	<b>DSMB</b>	17 3/4	19 1/4	42 3/4	26 1/2	—	—	—	22
<b>41477-30CO</b>	<b>DSMB</b>	17 3/4	19 1/4	46 3/4	30 1/2	—	—	—	23
<b>41477-34CO</b>	<b>DSMB</b>	17 3/4	19 1/4	49 3/4	33 1/2	—	—	—	24
<b>41477-26CO</b>	<b>USMB</b>	17 3/4	19 1/4	42 3/4	27 3/4	—	0.329	—	18.5
<b>41477-30CO</b>	<b>USMB</b>	17 3/4	19 1/4	46 3/4	31 3/4	—	0.329	—	19.5
<b>41477-34CO</b>	<b>USMB</b>	17 3/4	19 1/4	49 3/4	34 3/4	—	0.329	—	21.5

\* Refer to page 253 for accurate COM calculations/ Référez-vous à la page 253 pour des calculs précis de COM



42534-CO USNB

**SWIVEL STOOL**

(without memory return)

Upholstered seat

**TABOURET PIVOTANT**

(sans mécanisme à mémoire)

Siège rembourré

Metal color shown/ Couleur de métal montrée : Titanium (56)

**MEASUREMENTS / MESURES**

	W/L in/po	D/P in/po	H in/po	S in/po	A in/po	COM S* yd/vg	COM BR* yd/vg	W/P lb
<b>42534-26CO USNB</b>	18 1/4	18 1/4	27 1/8	27 1/8	—	0.315	—	16.5
<b>42534-30CO USNB</b>	19 3/4	19 3/4	31 1/8	31 1/8	—	0.315	—	17.5

\* Refer to page 253 for accurate COM calculations / Référez-vous à la page 253 pour des calculs précis de COM

# Opus



Back view / Vue arrière



39132-CO USUB

**CHAIR**

Upholstered seat and backrest

**CHAISE**

*Siège et dossier rembourrés*

Metal color shown / Couleur de métal montrée : Metallo (57)



40132-CO USUB

**NON SWIVEL STOOL**

Upholstered seat and backrest

**TABOURET NON PIVOTANT**

*Siège et dossier rembourrés*

Metal color shown / Couleur de métal montrée : Metallo (57)

**MEASUREMENTS / MESURES**

		W/L in/po	D/P in/po	H in/po	S in/po	A in/po	COM S* yd/vg	COM BR* yd/vg	W/P lb
<b>39132-CO</b>	<b>USUB</b>	21	21 1/4	33 1/4	18 1/2	—	0.382	0.458	16.5
<b>40132-26CO</b>	<b>USUB</b>	21	23 7/8	40	26 1/4	—	0.382	0.458	19.5
<b>40132-30CO</b>	<b>USUB</b>	21	23 7/8	44	30 1/4	—	0.382	0.458	20.5

\* Refer to page 253 for accurate COM calculations / Référez-vous à la page 253 pour des calculs précis de COM



## 39154-CO DSMB

### CHAIR

Distressed solid wood seat and metal backrest

### CHAISE

*Siège en bois massif usé et dossier en métal*

Metal and wood colors shown  
Couleurs de métal et de bois montrées : Harley (51)/Shady (84)



## 41454-CO USMB

### SWIVEL STOOL

(without memory return)

Upholstered seat and metal backrest

### TABOURET PIVOTANT

(sans mécanisme à mémoire)

*Siège rembourré et dossier en métal*

Metal color shown/ Couleur de métal montrée : Black coral/ Noir corail (25)

This design is now available as a non swivel stool. Please contact us for details and pricing. / Ce modèle est maintenant disponible en version non pivotante. Veuillez nous contacter pour les détails et les prix.



## 39154-CO USMB

### CHAIR

Upholstered seat and metal backrest

### CHAISE

*Siège rembourré et dossier en métal*

Metal color shown  
Couleur de métal montrée : Magnetite (24)

## MEASUREMENTS / MESURES

		W/L	D/P	H	S	A	COM S*	COM BR*	W/P
		in/ po	in/ po	in/ po	in/ po	in/ po	yd/ vg	yd/ vg	lb
<b>39154-CO</b>	<b>DSMB</b>	18 1/4	20 3/4	39 3/8	17 3/8	—	—	—	23.0
<b>39154-CO</b>	<b>USMB</b>	18 1/4	20 3/4	39 3/8	18 3/4	—	0.338	—	18.5
<b>41454-26CO</b>	<b>USMB</b>	18 1/4	20	40 3/4	26 3/4	—	0.338	—	27
<b>41454-30CO</b>	<b>USMB</b>	18 1/4	20	44 3/4	30 3/4	—	0.338	—	27
<b>41454-34CO</b>	<b>USMB</b>	18 3/4	20 1/2	48 1/2	34 3/4	—	0.338	—	28.5

\* Refer to page 253 for accurate COM calculations / Référez-vous à la page 253 pour des calculs précis de COM



# Oxford



41510-CO USUB

**SWIVEL STOOL**

(with memory return)

Upholstered seat  
and backrest

**TABOURET PIVOTANT**

(avec mécanisme à mémoire)

Siège et dossier  
rembourrés

Metal color shown/ Couleur de métal montrée : Cobrizo (75)

**MEASUREMENTS / MESURES**

		W/L	D/P	H	S	A	COM S*	COM BR*	W/P
		in/pt	in/pt	in/pt	in/pt	in/pt	yd/vg	yd/vg	lb
<b>41510-26CO</b>	<b>USUB</b>	17 3/4	20 3/4	41 3/4	26 1/4	—	0.329	0.190	27.5
<b>41510-30CO</b>	<b>USUB</b>	17 3/4	20 3/4	45 3/4	30 1/4	—	0.329	0.190	28.5
<b>41510-34CO</b>	<b>USUB</b>	17 3/4	21 1/4	49 3/4	34 1/4	—	0.329	0.190	30.5

\* Refer to page 253 for accurate COM calculations / Référez-vous à la page 253 pour des calculs précis de COM

# Pablo

# Leo

# Pedro

# Alto



### Pablo

35304-CO USUB

#### CHAIR

Upholstered seat and backrest

#### CHAISE

*Siège et dossier rembourrés*

Metal color shown  
Couleur de métal montrée :  
Oxidado (52)



### Leo

35305-CO USUB

#### CHAIR

Upholstered seat and backrest

#### CHAISE

*Siège et dossier rembourrés*

Metal color shown  
Couleur de métal montrée :  
Oxidado (52)



### Pedro

35308-CO USUB

#### CHAIR

Upholstered seat and backrest

#### CHAISE

*Siège et dossier rembourrés*

Metal color shown  
Couleur de métal montrée :  
Oxidado (52)



### Alto

35309-CO USUB

#### CHAIR

Upholstered seat and backrest

#### CHAISE

*Siège et dossier rembourrés*

Metal color shown / Couleur de métal montrée : Titanium (56)

## MEASUREMENTS / MESURES

		W/L	D/P	H	S	A	COM S*	COM BR*	W/P
		in/po	in/po	in/po	in/po	in/po	yd/vg	yd/vg	lb
<b>35304-CO</b>	<b>USUB</b>	19 1/2	24	33 1/4	18 7/8	—	0.449	0.646	18.5
<b>35305-CO</b>	<b>USUB</b>	19 1/2	26 1/4	40 1/4	18 7/8	—	0.449	0.801	18.5
<b>35308-CO</b>	<b>USUB</b>	17 1/2	22 1/2	33 1/2	18 7/8	—	0.409	0.495	17
<b>35309-CO</b>	<b>USUB</b>	17 1/2	23 1/2	38 1/2	18 7/4	—	0.409	0.678	16

\* Refer to page 253 for accurate COM calculations / Référez-vous à la page 253 pour des calculs précis de COM



49304-CO USUB

**NON SWIVEL STOOL**  
Upholstered seat and  
backrest

**TABOURET NON  
PIVOTANT**  
Siège et dossier rembourrés

Metal color shown / Couleur de métal montrée : Dayglam (53)



49305-CO USUB

**NON SWIVEL STOOL**  
Upholstered seat and  
backrest

**TABOURET NON  
PIVOTANT**  
Siège et dossier rembourrés

Metal color shown / Couleur de métal montrée : Dayglam (53)

**MEASUREMENTS / MESURES**

		W/L	D/P	H	S	A	COM S*	COM BR*	W/P
		in/po	in/po	in/po	in/po	in/po	yd/vg	yd/vg	lb
<b>49304-26CO</b>	<b>USUB</b>	17 1/2	22 3/4	41	26 3/8	—	0.409	0.495	26.5
<b>49304-30CO</b>	<b>USUB</b>	17 1/2	22 3/4	45	30 3/8	—	0.409	0.495	27.5
<b>49305-26CO</b>	<b>USUB</b>	19 1/2	23 3/4	41	26 3/8	—	0.449	0.646	27.5
<b>49305-30CO</b>	<b>USUB</b>	19 1/2	23 3/4	45	30 3/8	—	0.449	0.646	28.5

\* Refer to page 253 for accurate COM calculations / Référez-vous à la page 253 pour des calculs précis de COM



44412-CO USUB

**SWIVEL STOOL**  
(without memory return)

Upholstered seat  
and backrest

**TABOURET PIVOTANT**  
(sans mécanisme à mémoire)

*Siège et dossier  
rembourrés*

Metal color shown / Couleur de métal montrée : Magnétite (24)

## MEASUREMENTS / MESURES

		W/L in/po	D/P in/po	H in/po	S in/po	A in/po	COM S* yd/vg	COM BR* yd/vg	W/P lb
<b>44412-26CO</b>	<b>USUB</b>	22	19 1/2	34	26 3/8	34	0.3630	0.8870	22.5
<b>44412-30CO</b>	<b>USUB</b>	22	19 1/2	38	30 3/8	38	0.3630	0.8870	23.5

\* Refer to page 253 for accurate COM calculations / Référez-vous à la page 253 pour des calculs précis de COM

# Paul



49104-CO USMB

**NON SWIVEL STOOL**

Upholstered seat  
and metal backrest

**TABOURET NON  
PIVOTANT**

*Siège rembourré  
et dossier en métal*

Metal color shown / Couleur de métal montrée : -

**MEASUREMENTS / MESURES**

	W/L in/po	D/P in/po	H in/po	S in/po	A in/po	COM S* YD/VG	COM BR* YD/VG	W/P lb
<b>49104-26CO USMB</b>	20	22 1/4	41 5/8	26 3/4	—	0.356	—	18
<b>49104-30CO USMB</b>	20	22 1/4	46 3/4	31 3/4	—	0.356	—	19

\* Refer to page 253 for accurate COM calculations / Référez-vous à la page 253 pour des calculs précis de COM





Back view / Vue arrière



30103-CO USUB

**CHAIR**

Upholstered seat and backrest

Metal color shown / Couleur de métal montrée : Magnetite (24)

**CHAISE**

Siège et dossier rembourrés



40103-CO USUB

**NON SWIVEL STOOL**

Upholstered seat and backrest

Metal color shown / Couleur de métal montrée : Magnetite (24)

**TABOURET NON PIVOTANT**

Siège et dossier rembourrés

**MEASUREMENTS / MESURES**

		W/L in/po	D/P in/po	H in/po	S in/po	A in/po	COM S* yd/vg	COM BR* yd/vg	W/P lb
<b>30103-CO</b>	<b>USUB</b>	18 1/4	21 1/2	37 1/4	19	—	0.338	0.236	21.5
<b>40103-26CO</b>	<b>USUB</b>	18 1/4	20 1/2	39 5/8	27	—	0.338	0.176	21.5
<b>40103-30CO</b>	<b>USUB</b>	18 1/4	20 1/2	43 5/8	31	—	0.338	0.176	22.5

\* Refer to page 253 for accurate COM calculations / Référez-vous à la page 253 pour des calculs précis de COM

# Perry   Larry   Penny   Pacey



## **Perry**

35312-CO USUB

### **CHAIR**

Upholstered seat and backrest

### **CHAISE**

*Siège et dossier rembourrés*

Metal color shown  
Couleur de métal montrée :  
Magnetite (24)



## **Larry**

35313-CO USUB

### **CHAIR**

Upholstered seat and backrest

### **CHAISE**

*Siège et dossier rembourrés*

Metal color shown  
Couleur de métal montrée :  
Magnetite (24)



## **Penny**

35318-CO USUB

### **CHAIR**

Upholstered seat and backrest

### **CHAISE**

*Siège et dossier rembourrés*

Metal color shown  
Couleur de métal montrée :  
Magnetite (24)



## **Pacey**

35319-CO USUB

### **CHAIR**

Upholstered seat and backrest

### **CHAISE**

*Siège et dossier rembourrés*

Metal color shown / Couleur de métal montrée : Harley (51)

## MEASUREMENTS / MESURES

		W/L	D/P	H	S	A	COM S*	COM BR*	W/P
		in/ po	in/ po	in/ po	in/ po	in/ po	yd/ vg	yd/ vg	lb
<b>35312-CO</b>	<b>USUB</b>	19 1/2	24	32 1/2	18	—	0.449	0.646	18
<b>35313-CO</b>	<b>USUB</b>	19 1/2	26 1/4	39 1/2	18	—	0.449	0.801	16
<b>35318-CO</b>	<b>USUB</b>	17 1/2	22 1/2	32 3/4	18	—	0.409	0.495	17
<b>35319-CO</b>	<b>USUB</b>	17 1/2	23 1/2	38 1/4	18	—	0.409	0.678	18

\* Refer to page 253 for accurate COM calculations / Référez-vous à la page 253 pour des calculs précis de COM



45312-CO USUB

**NON SWIVEL STOOL**

Upholstered seat and backrest

**TABOURET NON PIVOTANT**

Siège et dossier rembourrés

Metal color shown / Couleur de métal montrée : Magnetite (24)



45315-CO USUB

**NON SWIVEL STOOL**

Upholstered seat and backrest

**TABOURET NON PIVOTANT**

Siège et dossier rembourrés

Metal color shown / Couleur de métal montrée : Magnetite (24)

**MEASUREMENTS / MESURES**

		W/L in/po	D/P in/po	H in/po	S in/po	A in/po	COM S* yd/vg	COM BR* yd/vg	W/P lb
<b>45312-26CO</b>	<b>USUB</b>	17 1/2	22 3/4	40 1/8	26 1/8	—	0.409	0.495	21.5
<b>45312-30CO</b>	<b>USUB</b>	17 1/2	22 3/4	44 1/8	30 1/8	—	0.409	0.495	23
<b>45315-26CO</b>	<b>USUB</b>	19 1/2	23 1/2	40 3/4	26 1/8	—	0.449	0.646	22.50
<b>45315-30CO</b>	<b>USUB</b>	19 1/2	23 1/2	44 3/4	30 1/8	—	0.449	0.646	23.50

\* Refer to page 253 for accurate COM calculations / Référez-vous à la page 253 pour des calculs précis de COM

# Phylo



42402-CO USNB

**SWIVEL STOOL**  
(without memory return)

Upholstered seat

**TABOURET PIVOTANT**  
(sans mécanisme à mémoire)

Siège rembourré

Metal color shown / Couleur de métal montrée : Magnetite (24)

## MEASUREMENTS / MESURES

	W/L in/po	D/P in/po	H in/po	S in/po	A in/po	COM S* yd/vg	COM BR* yd/vg	W/P lb
<b>42402-26CO USNB</b>	17	17	26	26	—	0.308	—	25
<b>42402-30CO USNB</b>	17	17	30	30	—	0.308	—	26

\* Refer to page 253 for accurate COM calculations / Référez-vous à la page 253 pour des calculs précis de COM



Back view / Vue arrière



## 41537-CO USUB

**SWIVEL STOOL**  
(with memory return and decorative nails)

Upholstered seat and backrest

**TABOURET PIVOTANT**  
(avec mécanisme à mémoire et clous décoratifs)

Siège et dossier rembourrés

Metal color shown / Couleur de métal montrée : Oxidado (52)

Nails only available in Black (NG)  
Clous uniquement disponibles en Noir (NG)

## 41557-CO USUB

**SWIVEL STOOL**  
(with memory return)

Upholstered seat and backrest

**TABOURET PIVOTANT**  
(avec mécanisme à mémoire)

Siège et dossier rembourrés

Metal color shown / Couleur de métal montrée : Oxidado (52)

### MEASUREMENTS / MESURES

		W/L in/po	D/P in/po	H in/po	S in/po	A in/po	COM S* yd/vg	COM BR* yd/vg	W/P lb
<b>41537-26CO</b>	<b>USUB</b>	23 1/2	21	36 1/4	27 1/2	—	1.491	—	25.5
<b>41537-30CO</b>	<b>USUB</b>	23 1/2	21	40 1/4	31 1/2	—	1.491	—	26.5
<b>41557-26CO</b>	<b>USUB</b>	23 1/2	21	36 1/4	27 1/2	—	1.491	—	25.5
<b>41557-30CO</b>	<b>USUB</b>	23 1/2	21	40 1/4	31 1/2	—	1.491	—	26.5

\* Refer to page 253 for accurate COM calculations / Référez-vous à la page 253 pour des calculs précis de COM



# Rally



## 31661-CO USDB

### CHAIR

Upholstered seat and distressed solid wood backrest

### CHAISE

*Siège rembourré et dossier en bois massif usé*

Metal and wood colors shown  
Couleurs de métal et de bois montrées : Harley (51)/Toasty (87)



Backless version available  
See Upright on page 169  
Version sans dossier disponible  
Voir Upright à la page 169



## 31661-CO DSDB

### CHAIR

Distressed solid wood seat and backrest

### CHAISE

*Siège et dossier en bois massif usé*

Metal and wood colors shown  
Couleurs de métal et de bois montrées : Harley (51)/Toasty (87)



## 40661-CO USDB

### NON SWIVEL STOOL

Upholstered seat and distressed solid wood backrest

### TABOURET NON PIVOTANT

*Siège rembourré et dossier en bois massif usé*

Metal and wood colors shown  
Couleurs de métal et de bois montrées : Harley (51)/Toasty (87)



## 40661-CO DSDB

### NON SWIVEL STOOL

Distressed solid wood seat and backrest

### TABOURET NON PIVOTANT

*Siège et dossier en bois massif usé*

Metal and wood colors shown/ Couleurs de métal et de bois montrées : Harley (51)/Toasty (87)

## MEASUREMENTS / MESURES

		W/L in/po	D/P in/po	H in/po	S in/po	A in/po	COM S* yd/vg	COM BR* yd/vg	W/P lb
31661-CO	DSDB	18	21 3/4	33 1/4	17 1/2	—	—	—	21
31661-CO	USDB	18	21 3/4	33 1/4	19 1/8	—	0.338	—	17.5
40661-26CO	DSDB	16 1/2	19 1/2	39	26	—	—	—	21
40661-30CO	DSDB	17	19 1/2	43	30	—	—	—	22
40661-26CO	USDB	16 1/2	19 1/2	39	27	—	0.324	—	19
40661-30CO	USDB	17	19 1/2	43	31	—	0.324	—	20

\* Refer to page 253 for accurate COM calculations / Référez-vous à la page 253 pour des calculs précis de COM



**NEW / NOUVEAU**

**30576-CO USUB**

**CHAIR**

Upholstered seat and backrest

**CHAISE**

*Siège et dossier rembourrés*

Metal color shown / Couleur de métal montrée : Metallo (57)



**NEW / NOUVEAU**

**41586-CO USUB**

**SWIVEL STOOL**

(without memory return)

Upholstered seat and backrest with metal armrests

**TABOURET PIVOTANT**

(sans mécanisme à mémoire)

*Siège et dossier rembourrés avec appuis-bras en métal*

Metal color shown / Couleur de métal montrée : Metallo (57)



**NEW / NOUVEAU**

**41576-CO USUB**

**SWIVEL STOOL**

(without memory return)

Upholstered seat and backrest

Metal color shown / Couleur de métal montrée : Metallo (57)

**TABOURET PIVOTANT**

(sans mécanisme à mémoire)

*Siège et dossier rembourrés*

**MEASUREMENTS / MESURES**

		W/L in/ po	D/P in/ po	H in/ po	S in/ po	A in/ po	COM S* yd/ vg	COM BR* yd/ vg	W/P lb
<b>30576-CO</b>	<b>USUB</b>	18 1/2	23 1/4	34 1/2	19	—	1.206	—	18
<b>41576-26CO</b>	<b>USUB</b>	18 1/2	23 3/8	42 3/4	27 1/2	—	1.206	—	24
<b>41576-30CO</b>	<b>USUB</b>	18 1/2	23 3/8	46 3/4	31 1/2	—	1.206	—	25
<b>41586-26CO</b>	<b>USUB</b>	23	23 3/8	42 3/4	27 1/2	35 3/8	1.206	—	28
<b>41586-30CO</b>	<b>USUB</b>	23	23 3/8	46 3/4	31 1/2	39 3/8	1.206	—	29

\* Refer to page 253 for accurate COM calculations / Référez-vous à la page 253 pour des calculs précis de COM

# Render



Backless version available  
See Rudy on page 152  
Version sans dossier disponible  
Voir Rudy à la page 152



41543-CO DSMB

**SWIVEL STOOL**

(without memory return)

Distressed solid wood seat  
and metal backrest

Metal and wood colors shown/ Couleurs de métal et de bois montrées :  
Cobrizo (75)/Sand dust (86)

**TABOURET PIVOTANT**

(sans mécanisme à mémoire)

Siège en bois massif usé  
et dossier en métal



41543-CO USMB

**SWIVEL STOOL**

(without memory return)

Upholstered seat and  
metal backrest

Metal color shown/ Couleur de métal montrée : Cobrizo (75)

**TABOURET PIVOTANT**

(sans mécanisme à mémoire)

Siège rembourré et dossier  
en métal

**MEASUREMENTS / MESURES**

		W/L in/po	D/P in/po	H in/po	S in/po	A in/po	COM S* yd/vg	COM BR* yd/vg	W/P lb
<b>41543-26CO</b>	<b>DSMB</b>	21 3/4	19 1/4	34 1/4	25 1/2	—	—	—	29.5
<b>41543-30CO</b>	<b>DSMB</b>	21 3/4	19 1/4	38 1/4	29 1/2	—	—	—	30.5
<b>41543-26CO</b>	<b>USMB</b>	21 3/4	19 1/4	34 1/4	26 3/4	—	0.315	—	26
<b>41543-30CO</b>	<b>USMB</b>	21 3/4	19 1/4	38 1/4	30 3/4	—	0.315	—	27

\* Refer to page 253 for accurate COM calculations/ Référez-vous à la page 253 pour des calculs précis de COM



**47642-CO USUB**  
**PEDESTAL SWIVEL STOOL**  
 (without memory return)

Upholstered seat and backrest  
 Round plate

**TABOURET PIÉDESTAL PIVOTANT**

(sans mécanisme à mémoire)

*Siège et dossier rembourrés*  
*Plaque ronde*

Metal color shown / Couleur de métal montrée : Titanium (56)



Backless version available  
 See Rudy on page 152  
 Version sans dossier disponible  
 Voir Rudy à la page 152



**41442-CO USUB**

**SWIVEL STOOL**  
 (without memory return)

Upholstered seat and backrest

Metal color shown / Couleur de métal montrée : Titanium (56)

**TABOURET PIVOTANT**  
 (sans mécanisme à mémoire)

*Siège et dossier rembourrés*

This design is now available as a non swivel stool. Please contact us for details and pricing. / Ce modèle est maintenant disponible en version non pivotante. Veuillez nous contacter pour les détails et les prix.



**48642-CO USUB**

**BOLT DOWN SWIVEL STOOL**  
 (without memory return)

Upholstered seat and backrest

**TABOURET PIVOTANT VISSÉ AU PLANCHER**

(sans mécanisme à mémoire)

*Siège et dossier rembourrés*

Metal color shown  
 Couleur de métal montrée : Titanium (56)

## MEASUREMENTS / MESURES

		W/L	D/P	H	S	A	COM S*	COM BR*	W/P
		in/ po	in/ po	in/ po	in/ po	in/ po	yd/ vg	yd/ vg	lb
<b>41442-26CO</b>	<b>USUB</b>	20 3/4	19 1/4	36	26 7/8	—	0.315	0.356	26.5
<b>41442-30CO</b>	<b>USUB</b>	20 3/4	19 1/4	40	30 7/8	—	0.315	0.356	27.5
<b>41442-34CO</b>	<b>USUB</b>	20 3/4	19 1/4	44	34 7/8	—	0.315	0.356	28.5
<b>47642-26CO</b>	<b>USUB</b>	20 3/4	19 1/4	35 7/8	26 1/8	—	0.315	0.356	43.5
<b>47642-30CO</b>	<b>USUB</b>	20 3/4	19 1/4	39 7/8	30 1/8	—	0.315	0.356	44.5
<b>48642-26CO</b>	<b>USUB</b>	20 3/4	19 1/4	36	26 1/4	—	0.315	0.356	37.5
<b>48642-30CO</b>	<b>USUB</b>	20 3/4	19 1/4	40	30 1/4	—	0.315	0.356	38.5

\* Refer to page 253 for accurate COM calculations / Référez-vous à la page 253 pour des calculs précis de COM

# Rudy



42442-CO USNB

**SWIVEL STOOL**  
(without memory return)

Upholstered seat

**TABOURET PIVOTANT**  
(sans mécanisme à mémoire)

Siège rembourré

Metal color shown/ Couleur de métal montrée : Snow (63)

This design is now available as a non swivel stool. Please contact us for details and pricing./ Ce modèle est maintenant disponible en version non pivotante. Veuillez nous contacter pour les détails et les prix.

## MEASUREMENTS / MESURES

		W/L	D/P	H	S	A	COM S*	COM BR*	W/P
		in/ po	in/ po	in/ po	in/ po	in/ po	yd/ vg	yd/ vg	lb
<b>42442-26CO</b>	<b>USNB</b>	17 3/4	17 3/4	26 7/8	26 7/8	—	0.315	—	22.5
<b>42442-30CO</b>	<b>USNB</b>	17 3/4	17 3/4	30 7/8	30 7/8	—	0.315	—	23.5
<b>42442-34CO</b>	<b>USNB</b>	17 3/4	17 3/4	34 7/8	34 7/8	—	0.315	—	24.5

\* Refer to page 253 for accurate COM calculations/ Référez-vous à la page 253 pour des calculs précis de COM





Back view / Vue arrière



41526-CO USUB

**SWIVEL STOOL**

(without memory return)

Upholstered seat and backrest

Metal color shown / Couleur de métal montrée : Oxidado (52)

**TABOURET PIVOTANT**

(sans mécanisme à mémoire)

Siège et dossier rembourrés

**MEASUREMENTS / MESURES**

		W/L	D/P	H	S	A	COM S*	COM BR*	W/P
		in/po	in/po	in/po	in/po	in/po	yd/vg	yd/vg	lb
<b>41526-26CO</b>	<b>USUB</b>	22 1/4	20 3/8	34 3/4	26 3/4	—	0.315	0.600	30,5
<b>41526-30CO</b>	<b>USUB</b>	22 1/4	20 3/8	38 3/4	30 3/4	—	0.315	0.600	32
<b>41526-34CO</b>	<b>USUB</b>	22 1/4	20 3/8	42 3/4	34 3/4	—	0.315	0.600	33,5

\* Refer to page 253 for accurate COM calculations / Référez-vous à la page 253 pour des calculs précis de COM



40034-CO DSNB

**NON SWIVEL STOOL**  
Distressed solid  
wood seat

**TABOURET NON  
PIVOTANT**  
*Siège en bois massif usé*

Metal and wood colors shown/ *Couleurs de métal et de bois montrées* :  
Falcon (74)/Toasty (87)



40034-CO USNB

**NON SWIVEL STOOL**  
Upholstered seat

**TABOURET NON  
PIVOTANT**  
*Siège rembourré*

Metal color shown/ *Couleur de métal montrée* : Magnetite (24)

## MEASUREMENTS / MESURES

	W/L	D/P	H	S	A	COM S*	COM BR*	W/P
	in/ po	in/ po	in/ po	in/ po	in/ po	yd/ vg	yd/ vg	lb
<b>40034-24CO DSNB</b>	16 1/2	16 1/2	24 1/4	24 1/4	—	—	—	15
<b>40034-30CO DSNB</b>	16 1/2	16 1/2	30 1/4	30 1/4	—	—	—	16
<b>40034-24CO USNB</b>	16 1/2	16 1/2	25 1/2	25 1/2	—	0.303	—	13.5
<b>40034-30CO USNB</b>	16 1/2	16 1/2	31 1/2	31 1/2	—	0.303	—	14.5

\* Refer to page 253 for accurate COM calculations/ *Référez-vous à la page 253 pour des calculs précis de COM*

# Scroller



Backless version available  
See Uplift on page 168  
*Version sans dossier disponible  
Voir Uplift à la page 168*



41624-CO DSMB

**SCREW STOOL**

Distressed solid wood seat  
and metal backrest

**TABOURET À VIS**

*Siège en bois massif usé  
et dossier en métal*

Metal and wood colors shown/ *Couleurs de métal et de bois montrées* :  
Black coral/ *Noir corail* (25)/ Toasty (87)



41624-CO USMB

**SCREW STOOL**

Upholstered seat and  
metal backrest

**TABOURET À VIS**

*Siège rembourré et  
dossier en métal*

Metal color shown/ *Couleur de métal montrée* : Black coral/ *Noir corail* (25)

**MEASUREMENTS / MESURES**

		W/L in/ po	D/P in/ po	H in/ po	S in/ po	A in/ po	COM S* yd/ vg	COM BR* yd/ vg	W/P lb
<b>41624-CO</b>	<b>DSMB</b>	17 3/4	17 3/4	31 - 36	24 1/4 - 29 1/4	—	—	—	21.5
<b>41624-CO</b>	<b>USMB</b>	17 3/4	17 3/4	31 - 36	25 - 30	—	0.252	—	20.5

\* Refer to page 253 for accurate COM calculations/ *Référez-vous à la page 253 pour des calculs précis de COM*

# Sinclair



**NEW / NOUVEAU**

44501-CO USNB

**SWIVEL STOOL**  
(without memory return)

Upholstered seat

**TABOURET PIVOTANT**  
(sans mécanisme à mémoire)

Siège rembourré

Metal color shown / Couleur de métal montrée : Cobrizo (75)

## MEASUREMENTS / MESURES

		W/L in/po	D/P in/po	H in/po	S in/po	A in/po	COM S* yd/vg	COM BR* yd/vg	W/P lb
<b>44501-26CO</b>	<b>USNB</b>	17 5/8	17 5/8	25 1/4	25 1/4	—	0.292	—	13.5
<b>44501-30CO</b>	<b>USNB</b>	17 5/8	17 5/8	29 1/4	29 1/4	—	0.292	—	14.5

\* Refer to page 253 for accurate COM calculations / Référez-vous à la page 253 pour des calculs précis de COM



## 30529-CO DSDB

### CHAIR

Distressed solid wood seat and metal backrest with distressed solid wood accent

### CHAISE

*Siège en bois massif usé et dossier en métal avec accent en bois massif usé*

Metal and wood colors shown  
*Couleurs de métal et de bois montrées :*  
Black coral / Noir corail (25) / Toasty (87)



## 30529-CO USDB

### CHAIR

Upholstered seat and metal backrest with distressed solid wood accent

### CHAISE

*Siège rembourré et dossier en métal avec accent en bois massif usé*

Metal and wood colors shown  
*Couleurs de métal et de bois montrées :*  
Black coral / Noir corail (25) / Stone dust (89)



## 41529-CO USDB

### SWIVEL STOOL

(without memory return)

Upholstered seat and metal backrest with distressed solid wood accent

### TABOURET PIVOTANT

(sans mécanisme à mémoire)

*Siège rembourré et dossier en métal avec accent en bois massif usé*

Metal and wood colors shown  
*Couleurs de métal et de bois montrées :*  
Black coral / Noir corail (25) / Stone dust (89)



## 41529-CO DSDB

### SWIVEL STOOL

(without memory return)

Distressed solid wood seat and metal backrest with distressed solid wood accent

### TABOURET PIVOTANT

(sans mécanisme à mémoire)

*Siège en bois massif usé et dossier en métal avec accent en bois massif usé*

Metal and wood colors shown / *Couleurs de métal et de bois montrées :*  
Black coral / Noir corail (25) / Toasty (87)

## MEASUREMENTS / MESURES

		W/L in/po	D/P in/po	H in/po	S in/po	A in/po	COM S* yd/vg	COM BR* yd/vg	W/P lb
30529-CO	DSDB	18 1/2	21 1/4	35 7/8	17 3/8	—	—	—	21.5
30529-CO	USDB	18 1/2	21 1/4	35 7/8	18 5/8	—	0.338	—	18.5
41529-26CO	DSDB	18 1/2	22 1/4	42 3/8	25 3/8	—	—	—	35
41529-30CO	DSDB	18 1/2	22 1/4	46 3/8	29 3/8	—	—	—	36
41529-26CO	USDB	18 1/2	22 1/4	42 3/8	26 1/2	—	0.329	—	31.5
41529-30CO	USDB	18 1/2	22 1/4	46 3/8	30 1/2	—	0.329	—	32.5

\* Refer to page 253 for accurate COM calculations / *Référez-vous à la page 253 pour des calculs précis de COM*



# Staten



41474-CO USUB

**SWIVEL STOOL**

(without memory return)

Upholstered seat and backrest

**TABOURET PIVOTANT**

(sans mécanisme à mémoire)

Siège et dossier rembourrés

Metal color shown/ Couleur de métal montrée : Titanium (56)

**MEASUREMENTS / MESURES**

		W/L in/po	D/P in/po	H in/po	S in/po	A in/po	COM S* yd/vg	COM BR* yd/vg	W/P lb
<b>41474-26CO</b>	<b>USUB</b>	18	21 1/8	34 3/4	26	—	0.382	0.206	26.5
<b>41474-30CO</b>	<b>USUB</b>	18	21 1/8	38 3/4	30	—	0.382	0.206	28.5

\* Refer to page 253 for accurate COM calculations / Référez-vous à la page 253 pour des calculs précis de COM



## 41545-CO USUB

### SWIVEL STOOL

(without memory return)

Upholstered seat and backrest

### TABOURET PIVOTANT

(sans mécanisme à mémoire)

Siège et dossier rembourrés

Metal color shown/ Couleur de métal montrée : Magnetite (24)

## MEASUREMENTS / MESURES

		W/L in/po	D/P in/po	H in/po	S in/po	A in/po	COM S* yd/vg	COM BR* yd/vg	W/P lb
<b>41545-26CO</b>	<b>USUB</b>	21 3/4	20 1/2	33 1/8	27	—	0.389	0.462	27
<b>41545-30CO</b>	<b>USUB</b>	21 3/4	20 1/2	37 1/8	31	—	0.389	0.462	28

\* Refer to page 253 for accurate COM calculations / Référez-vous à la page 253 pour des calculs précis de COM

# Swan



42496-CO USNB

**SWIVEL STOOL**  
(without memory return)

Upholstered seat

**TABOURET PIVOTANT**  
(sans mécanisme à mémoire)

Siège rembourré

Metal color shown / Couleur de métal montrée : Oxidado (52)

## MEASUREMENTS / MESURES

	W/L in/po	D/P in/po	H in/po	S in/po	A in/po	COM S* yd/vg	COM BR* yd/vg	W/P lb
<b>42496-26CO USNB</b>	17	17	26 1/8	26 1/8	—	0.286	—	15
<b>42496-30CO USNB</b>	17	17	30 1/8	30 1/8	—	0.286	—	16

\* Refer to page 253 for accurate COM calculations / Référez-vous à la page 253 pour des calculs précis de COM



42444-CO DSNB

**SWIVEL STOOL**

(without memory return)

Distressed solid wood seat

**TABOURET PIVOTANT**

(sans mécanisme à mémoire)

Siège en bois massif usé

Metal and wood colors shown/ Couleurs de métal et de bois montrées : Magnetite (24)/ Stone dust (89)



42444-CO USNB

**SWIVEL STOOL**

(without memory return)

Upholstered seat

**TABOURET PIVOTANT**

(sans mécanisme à mémoire)

Siège rembourré

Metal color shown/ Couleur de métal montrée : Magnetite (24)

**MEASUREMENTS / MESURES**

		W/L	D/P	H	S	A	COM S*	COM BR*	W/P
		in/po	in/po	in/po	in/po	in/po	yd/vg	yd/vg	lb
<b>42444-26CO</b>	<b>DSNB</b>	17 5/8	17 5/8	25	25	—	—	—	22.5
<b>42444-30CO</b>	<b>DSNB</b>	17 5/8	17 5/8	29	29	—	—	—	23.5
<b>42444-34CO</b>	<b>DSNB</b>	17 5/8	17 5/8	33	33	—	—	—	26
<b>42444-26CO</b>	<b>USNB</b>	17 5/8	17 5/8	26 3/8	26 3/8	—	0.286	—	20
<b>42444-30CO</b>	<b>USNB</b>	17 5/8	17 5/8	30 3/8	30 3/8	—	0.286	—	21
<b>42444-34CO</b>	<b>USNB</b>	17 5/8	17 5/8	34 3/8	34 3/8	—	0.286	—	23.5

\* Refer to page 253 for accurate COM calculations/ Référez-vous à la page 253 pour des calculs précis de COM

# Symmetry



31669-CO USDB

## CHAIR

Upholstered seat and distressed solid wood backrest

### CHAISE

*Siège rembourré et dossier en bois massif usé*

Metal and wood colors shown  
Couleurs de métal et de bois montrées : Harley (51)/Toasty (87)



Backless version available  
See Architect on page 67  
Version sans dossier disponible  
Voir Architect à la page 67



31669-CO DSDB

## CHAIR

Distressed solid wood seat and backrest

### CHAISE

*Siège et dossier en bois massif usé*

Metal and wood colors shown  
Couleurs de métal et de bois montrées : Harley (51)/Toasty (87)



41669-CO DSDB

## SCREW STOOL

Distressed solid wood seat and backrest

### TABOURET À VIS

*Siège et dossier en bois massif usé*

Metal and wood colors shown  
Couleurs de métal et de bois montrées : Harley (51)/Toasty (87)



41669-CO USDB

## SCREW STOOL

Upholstered seat and distressed solid wood backrest

### TABOURET À VIS

*Siège rembourré et dossier en bois massif usé*

Metal and wood colors shown/ Couleurs de métal et de bois montrées : Harley (51)/Toasty (87)

## MEASUREMENTS / MESURES

		W/L in./po	D/P in./po	H in./po	S in./po	A in./po	COM S* yd./vg	COM BR* yd./vg	W/P lb
31669-CO	DSDB	18	21 3/4	33 1/4	17 1/2	—	—	—	21
31669-CO	USDB	18	21 3/4	33 1/4	19 1/8	—	0.338	—	17.5
41669-CO	DSDB	16 1/4	19 7/8	37 3/4 - 43 1/8	25 - 30 3/8	—	—	—	23.5
41669-CO	USDB	16 1/4	19 7/8	37 3/4 - 43 1/8	26 - 31 3/8	—	0.280	—	21.0

\* Refer to page 253 for accurate COM calculations / Référez-vous à la page 253 pour des calculs précis de COM



## 39124-CO DSMB

### CHAIR

Distressed solid wood seat and metal backrest

### CHAISE

*Siège en bois massif usé et dossier en métal*

Metal and wood colors shown  
*Couleurs de métal et de bois montrées :*  
Harley (51)/Toasty (87)



## 39124-CO USMB

### CHAIR

Upholstered seat and metal backrest

### CHAISE

*Siège rembourré et dossier en métal*

Metal color shown  
*Couleur de métal montrée :*  
Magnetite (24)



## 39144-CO USMB

### ARMCHAIR

Upholstered seat with metal backrest and armrests

### CHAISE AVEC APPUIS-BRAS

*Siège rembourré avec dossier et appuis-bras en métal*

Metal color shown  
*Couleur de métal montrée :*  
Magnetite (24)

## 39144-CO DSMB

### ARMCHAIR

Distressed solid wood seat with metal backrest and armrests

### CHAISE AVEC APPUIS-BRAS

*Siège en bois massif usé avec dossier et appuis-bras en métal*

Metal and wood colors shown/*Couleurs de métal et de bois montrées :*  
Harley (51)/Toasty (87)

## MEASUREMENTS / MESURES

		W/L in/po	D/P in/po	H in/po	S in/po	A in/po	COM S* yd/vg	COM BR* yd/vg	W/P lb
<b>39124-CO</b>	<b>DSMB</b>	19 3/4	21 5/8	34 3/8	17 5/8	—	—	—	20.5
<b>39124-CO</b>	<b>USMB</b>	19 3/4	21	34 3/8	19	—	0.356	—	16.5
<b>39144-CO</b>	<b>DSMB</b>	21 1/4	21 5/8	34 3/8	17 5/8	26 1/8	—	—	21.0
<b>39144-CO</b>	<b>USMB</b>	21 1/4	21 1/2	34 3/8	19	26 1/4	0.356	—	17

\* Refer to page 253 for accurate COM calculations / *Référez-vous à la page 253 pour des calculs précis de COM*



# Tower



Backless version available  
See Swice on page 161  
Version sans dossier disponible  
Voir Swice à la page 161



41475-CO USUB

**SWIVEL STOOL**  
(without memory return)

Upholstered seat and  
backrest

Metal color shown/ Couleur de métal montrée : Magnetite (24)

**TABOURET PIVOTANT**  
(sans mécanisme à mémoire)

Siège et dossier  
rembourrés

## MEASUREMENTS / MESURES

		W/L in/po	D/P in/po	H in/po	S in/po	A in/po	COM S* yd/vg	COM BR* yd/vg	W/P lb
<b>41475-26CO</b>	<b>USUB</b>	17 5/8	21 1/4	37 1/2	26 1/4	—	0.286	0.19	27.5
<b>41475-30CO</b>	<b>USUB</b>	17 5/8	21 1/4	41 1/2	30 1/4	—	0.286	0.19	28

\* Refer to page 253 for accurate COM calculations / Référez-vous à la page 253 pour des calculs précis de COM



**NEW / NOUVEAU**

**44443-CO USUB**

**SWIVEL STOOL**  
(without memory return)

Upholstered seat and backrest

**TABOURET PIVOTANT**  
(sans mécanisme à mémoire)

*Siège et dossier rembourrés*

Metal color shown / Couleur de métal montrée : Titanium (56)

## MEASUREMENTS / MESURES

		W/L in/po	D/P in/po	H in/po	S in/po	A in/po	COM S* yd/vg	COM BR* yd/vg	W/P lb
<b>44443-26CO USUB</b>		18 1/4	18 5/8	33 3/4	26 3/4	—	0.338	0.196	29.5
<b>44443-30CO USUB</b>		18 1/4	18 5/8	37 3/4	30 3/4	—	0.338	0.196	31

\* Refer to page 253 for accurate COM calculations / Référez-vous à la page 253 pour des calculs précis de COM



41493-CO DSMB

**SWIVEL STOOL**

(without memory return)

Distressed solid wood seat with metal backrest and armrests

**TABOURET PIVOTANT**

(sans mécanisme à mémoire)

Siège en bois massif usé avec dossier et appuis-bras en métal

Metal and wood colors shown / Couleurs de métal et de bois montrées : Magnetite (24) / Stone dust (89)



41493-CO USMB

**SWIVEL STOOL**

(without memory return)

Upholstered seat with metal backrest and armrests

**TABOURET PIVOTANT**

(sans mécanisme à mémoire)

Siège rembourré avec dossier et appuis-bras en métal

Metal color shown / Couleur de métal montrée : Magnetite (24)

**MEASUREMENTS / MESURES**

		W/L in/po	D/P in/po	H in/po	S in/po	A in/po	COM S* yd/vg	COM BR* yd/vg	W/P lb
<b>41493-26CO</b>	<b>DSMB</b>	21 1/2	19 1/4	33 1/4	26	33 1/4	—	—	22.5
<b>41493-30CO</b>	<b>DSMB</b>	21 1/2	19 1/4	37 1/4	29	37 1/4	—	—	24.5
<b>41493-26CO</b>	<b>USMB</b>	21 1/2	19 3/4	33 1/4	27 1/4	33 1/4	0.340	—	22.5
<b>41493-30CO</b>	<b>USMB</b>	21 1/2	19 3/4	37 1/4	31 1/4	37 1/4	0.340	—	24.5

\* Refer to page 253 for accurate COM calculations / Référez-vous à la page 253 pour des calculs précis de COM



41663-CO USDB

**SWIVEL STOOL**

(without memory return)

Upholstered seat and distressed solid wood backrest

**TABOURET PIVOTANT**

(sans mécanisme à mémoire)

Siège rembourré et dossier en bois massif usé

Metal and wood colors shown  
Couleurs de métal et de bois montrées : Harley (51)/Toasty (87)



41666-CO DSMB

**SWIVEL STOOL**

(without memory return)

Distressed solid wood seat and metal backrest

**TABOURET PIVOTANT**

(sans mécanisme à mémoire)

Siège en bois massif usé et dossier en métal

Metal and wood colors shown  
Couleurs de métal et de bois montrées : Harley (51)/Toasty (87)



41666-CO USMB

**SWIVEL STOOL**

(without memory return)

Upholstered seat and metal backrest

**TABOURET PIVOTANT**

(sans mécanisme à mémoire)

Siège rembourré et dossier en métal

Metal color shown  
Couleur de métal montrée : Harley (51)



41663-CO DSDB

**SWIVEL STOOL**

(without memory return)

Distressed solid wood seat and backrest

**TABOURET PIVOTANT**

(sans mécanisme à mémoire)

Siège et dossier en bois massif usé

Metal and wood colors shown / Couleurs de métal et de bois montrées : Harley (51)/Toasty (87)

**MEASUREMENTS / MESURES**

		W/L	D/P	H	S	A	COM S*	COM BR*	W/P
		in/ po	in/ po	in/ po	in/ po	in/ po	yd/ vg	yd/ vg	lb
41663-26CO	DSDB	16 3/4	20 1/2	38 3/4	25 1/2	—	—	—	23.5
41663-30CO	DSDB	16 3/4	20 1/2	42 3/4	29 1/2	—	—	—	24.5
41663-26CO	USDB	17 1/2	20 1/2	38 3/4	26 7/8	—	0.329	—	20.5
41663-30CO	USDB	17 1/2	20 1/2	42 3/4	30 7/8	—	0.329	—	21.5
41666-26CO	DSMB	16 3/4	20 1/2	37 3/4	25 1/2	—	—	—	24.5
41666-30CO	DSMB	16 3/4	20 1/2	41 3/4	29 1/2	—	—	—	25.5
41666-26CO	USMB	17 1/2	20 1/2	37 3/4	26 7/8	—	0.329	—	21.5
41666-30CO	USMB	17 1/2	20 1/2	41 3/4	30 7/8	—	0.329	—	22.5

\* Refer to page 253 for accurate COM calculations / Référez-vous à la page 253 pour des calculs précis de COM

# Uplift



40614-CO USMB

**SCREW STOOL**

Upholstered seat and metal backrest

**TABOURET À VIS**

*Siège rembourré et dossier en métal*

Metal color shown  
Couleur de métal montrée :  
Oxidado (52)



42614-CO USNB

**SCREW STOOL**

Upholstered seat

**TABOURET À VIS**

*Siège rembourré*

Metal color shown  
Couleur de métal montrée :  
Oxidado (52)



42614-CO DSNB

**SCREW STOOL**

Distressed solid wood seat

**TABOURET À VIS**

*Siège en bois massif usé*

Metal and wood colors shown  
Couleurs de métal et de bois montrées :  
Black coral / Noir corail (25) / Toasty (87)



40614-CO DSMB

**SCREW STOOL**

Distressed solid wood seat and metal backrest

**TABOURET À VIS**

*Siège en bois massif usé et dossier en métal*

Metal and wood colors shown / Couleurs de métal et de bois montrées :  
Black coral / Noir corail (25) / Toasty (87)

**MEASUREMENTS / MESURES**

		W/L in/po	D/P in/po	H in/po	S in/po	A in/po	COM S* yd/vg	COM BR* yd/vg	W/P lb
40614-CO	DSMB	17 3/4	17 3/4	31 - 36	24 1/4 - 29 1/4	—	—	—	22.5
40614-CO	USMB	17 3/4	17 3/4	31 - 36	25 - 30	—	0.252	—	21.5
42614-CO	DSNB	16 1/4	16 1/4	24 1/4 - 29 1/4	24 1/4 - 29 1/4	—	—	—	17
42614-CO	USNB	16 1/4	16 1/4	25 - 30	25 - 30	—	0.252	—	16

\* Refer to page 253 for accurate COM calculations / Référez-vous à la page 253 pour des calculs précis de COM

# Upright



40264-CO DSDB

**NON SWIVEL STOOL**  
Distressed solid wood seat and backrest

**TABOURET NON PIVOTANT**

*Siège et dossier en bois massif usé*

Metal and wood colors shown  
*Couleurs de métal et de bois montrées :*  
Oxidado (52)/Toasty (87)



Chair version available  
See Architect on page 65  
*Version chaise disponible*  
Voir Architect à la page 65



42564-CO DSNB

**NON SWIVEL STOOL**  
Distressed solid wood seat

**TABOURET NON PIVOTANT**

*Siège en bois massif usé*

Metal and wood colors shown  
*Couleurs de métal et de bois montrées :*  
Oxidado (52)/Toasty (87)



42564-CO USNB

**NON SWIVEL STOOL**  
Upholstered seat

**TABOURET NON PIVOTANT**

*Siège rembourré*

Metal color shown  
*Couleur de métal montrée :*  
Oxidado (52)

40264-CO USDB

**NON SWIVEL STOOL**  
Upholstered seat and distressed solid wood backrest

**TABOURET NON PIVOTANT**

*Siège rembourré et dossier en bois massif usé*

Metal and wood colors shown/  
*Couleurs de métal et de bois montrées :*  
Oxidado (52)/Toasty (87)

## MEASUREMENTS / MESURES

		W/L	D/P	H	S	A	COM S*	COM BR*	W/P
		in/ po	in/ po	in/ po	in/ po	in/ po	yd/ vg	yd/ vg	lb
40264-26CO	DSDB	16 1/2	20	38	26	—	—	—	24.5
40264-30CO	DSDB	17	20	42	30	—	—	—	26
40264-26CO	USDB	16 1/2	20	38	27	—	0.324	—	22.5
40264-30CO	USDB	17	20	42	31	—	0.324	—	24
42564-26CO	DSNB	16 1/2	16 1/2	26	26	—	—	—	21.5
42564-30CO	DSNB	17	17	30	30	—	—	—	23
42564-26CO	USNB	16 1/2	16 1/2	27	27	—	0.324	—	19.5
42564-30CO	USNB	17	17	31	31	—	0.324	—	21

\* Refer to page 253 for accurate COM calculations / *Référez-vous à la page 253 pour des calculs précis de COM*



# Washington



30303-CO USMB

**CHAIR**

Upholstered seat and metal backrest

**CHAISE**

*Siège rembourré et dossier en métal*

Metal color shown / Couleur de métal montrée : Cobrizo (75)



40303-CO USMB

**NON SWIVEL STOOL**

Upholstered seat and metal backrest

**TABOURET NON PIVOTANT**

*Siège rembourré et dossier en métal*

Metal color shown / Couleur de métal montrée : Cobrizo (75)

**MEASUREMENTS / MESURES**

		W/L in/po	D/P in/po	H in/po	S in/po	A in/po	COM S* yd/vg	COM BR* yd/vg	W/P lb
<b>30303-CO</b>	<b>USMB</b>	18 1/4	22 3/4	34	18 3/4	—	0.338	—	16.5
<b>40303-26CO</b>	<b>USMB</b>	18 1/4	21 3/4	39 1/4	26 3/4	—	0.338	—	18
<b>40303-30CO</b>	<b>USMB</b>	18 1/4	21 3/4	43 1/4	30 3/4	—	0.338	—	19

\* Refer to page 253 for accurate COM calculations / Référez-vous à la page 253 pour des calculs précis de COM



30330-CO USUB

**CHAIR**

Upholstered seat and backrest

Metal color shown / Couleur de métal montrée : Titanium (56)

**CHAISE**

*Siège et dossier rembourrés*



41330-CO USUB

**SWIVEL STOOL**

(with memory return)

Upholstered seat and backrest

Metal color shown / Couleur de métal montrée : Titanium (56)

**TABOURET PIVOTANT**

*(avec mécanisme à mémoire)*

*Siège et dossier rembourrés*

**MEASUREMENTS / MESURES**

		W/L in/po	D/P in/po	H in/po	S in/po	A in/po	COM S* yd/vg	COM BR* yd/vg	W/P lb
<b>30330-CO</b>	<b>USUB</b>	18 1/2	21 1/4	35 1/2	18	—	0.982	—	19
<b>41330-26CO</b>	<b>USUB</b>	18 1/2	21 1/4	44 3/4	27 3/4	—	0.982	—	24
<b>41330-30CO</b>	<b>USUB</b>	18 1/2	21 1/4	48 3/4	31 3/4	—	0.982	—	25

\* Refer to page 253 for accurate COM calculations / Référez-vous à la page 253 pour des calculs précis de COM

# Wellington



41516-CO USMB

**SWIVEL STOOL**

(without memory return)

Upholstered seat and metal backrest

Metal color shown/ Couleur de métal montrée : Oxidado (52)

**TABOURET PIVOTANT**

(sans mécanisme à mémoire)

Siège rembourré et dossier en métal

**MEASUREMENTS / MESURES**

		W/L in/ po	D/P in/ po	H in/ po	S in/ po	A in/ po	COM S* yd/ vg	COM BR* yd/ vg	W/P lb
<b>41516-26CO</b>	<b>USMB</b>	19 1/2	21 1/2	41	27	—	0.356	—	24.5
<b>41516-30CO</b>	<b>USMB</b>	19 1/2	21 1/2	45 1/8	31 1/8	—	0.356	—	25.5

\* Refer to page 253 for accurate COM calculations/ Référez-vous à la page 253 pour des calculs précis de COM



**NEW / NOUVEAU**

**41578-CO USUB**

**SWIVEL STOOL**

(without memory return)

Upholstered seat and backrest

**TABOURET PIVOTANT**

(sans mécanisme à mémoire)

Siège et dossier rembourrés

Metal color shown / Couleur de métal montrée : Sun gold (27)

## MEASUREMENTS / MESURES

		W/L in/po	D/P in/po	H in/po	S in/po	A in/po	COM S* yd/vg	COM BR* yd/vg	W/P lb
<b>41578-26CO</b>	<b>USUB</b>	21 3/4	22 1/4	37	26 1/2	—	1.204	—	26
<b>41578-30CO</b>	<b>USUB</b>	21 3/4	22 1/4	41	30 1/2	—	1.204	—	27

\* Refer to page 253 for accurate COM calculations / Référez-vous à la page 253 pour des calculs précis de COM



30534-CO USUB

**SWIVEL CHAIR**

(with memory return)

Upholstered seat and backrest

Metal color shown/ Couleur de métal montrée : Sun gold (27)

**CHAISE PIVOTANTE**

(avec mécanisme à mémoire)

Siège et dossier rembourrés



41534-CO USUB

**SWIVEL STOOL**

(with memory return)

Upholstered seat and backrest

Metal color shown/ Couleur de métal montrée : Sun gold (27)

**TABOURET PIVOTANT**

(avec mécanisme à mémoire)

Siège et dossier rembourrés

**MEASUREMENTS / MESURES**

		W/L in/po	D/P in/po	H in/po	S in/po	A in/po	COM S* yd/vg	COM BR* yd/vg	W/P lb
<b>30534-CO</b>	<b>USUB</b>	22	24	35	19 1/2	—	1.557	—	21
<b>41534-26CO</b>	<b>USUB</b>	22	24	43 1/4	27 3/4	—	1.557	—	23.5
<b>41534-30CO</b>	<b>USUB</b>	22	24	47 1/4	31 3/4	—	1.557	—	24.5

\* Refer to page 253 for accurate COM calculations / Référez-vous à la page 253 pour des calculs précis de COM



**NEW / NOUVEAU**

**39570-CO USUB**

**CHAIR**

Upholstered seat and backrest

**CHAISE**

*Siège et dossier rembourrés*

Metal color shown / Couleur de métal montrée : Oxidado (52)



**NEW / NOUVEAU**

**41570-CO USUB**

**SWIVEL STOOL**

(without memory return)

Upholstered seat and backrest

**TABOURET PIVOTANT**

*(sans mécanisme à mémoire)*

*Siège et dossier rembourrés*

Metal color shown / Couleur de métal montrée : Oxidado (52)

**MEASUREMENTS / MESURES**

		W/L	D/P	H	S	A	COM S*	COM BR*	W/P
		in/po	in/po	in/po	in/po	in/po	yd/vg	yd/vg	lb
<b>39570-CO</b>	<b>USUB</b>	19 1/4	21 1/2	32 1/4	19 1/8	—	0.338	0.36	16
<b>41570-26CO</b>	<b>USUB</b>	19 1/4	20	40 3/4	27 3/8	—	0.338	0.36	24.5
<b>41570-30CO</b>	<b>USUB</b>	19 1/4	20	44 3/4	31 3/8	—	0.338	0.36	25.5

\* Refer to page 253 for accurate COM calculations / Référez-vous à la page 253 pour des calculs précis de COM





30474-CO USUB

**BENCH**

(short version)

Upholstered seat  
and backrest

Metal color shown/ Couleur de métal montrée : Titanium (56)

**BANC**

(version courte)

Siège et dossier  
rembourrés

30478-CO USUB

**BENCH**

(long version)

Upholstered seat  
and backrest

Metal color shown/ Couleur de métal montrée : Titanium (56)

**BANC**

(version longue)

Siège et dossier  
rembourrés

**MEASUREMENTS / MESURES**

		W/L in/ po	D/P in/ po	H in/ po	S in/ po	A in/ po	COM <sub>S</sub> * yd/ vg	COM <sub>BR</sub> * yd/ vg	W/P lb
<b>30474-CO</b>	<b>USUB</b>	48	24	33 1/4	18 5/8	—	0.887	1.442	45
<b>30478-CO</b>	<b>USUB</b>	72	24	33 1/4	18 5/8	—	1.255	2.112	67

\* Refer to page 253 for accurate COM calculations/ Référez-vous à la page 253 pour des calculs précis de COM



40372-CO USUB

**BENCH**

Upholstered seat and backrest

**BANC**

Siège et dossier rembourrés

Metal color shown/ Couleur de métal montrée : Dayglam (53)



30472-CO USUB

**BENCH**

(short version)

Upholstered seat and backrest

Metal color shown/ Couleur de métal montrée : Black coral/ Noir corail (25)

**BANC**

(version courte)

Siège et dossier rembourrés



30473-CO USUB

**BENCH**

(long version)

Upholstered seat and backrest

Metal color shown/ Couleur de métal montrée : Black coral/ Noir corail (25)

**BANC**

(version longue)

Siège et dossier rembourrés

## MEASUREMENTS / MESURES

		W/L in/ po	D/P in/ po	H in/ po	S in/ po	A in/ po	COM <sup>s*</sup> yd/ vg	COM <sup>BR*</sup> yd/ vg	W/P lb
<b>30472-CO</b>	<b>USUB</b>	48	24	33 1/4	18 5/8	—	0.887	1.442	48.5
<b>30473-CO</b>	<b>USUB</b>	72	24	33 1/4	18 5/8	—	1.255	2.112	68.5
<b>40372-26CO</b>	<b>USUB</b>	48	23 1/4	41 1/4	26 1/2	—	0.887	1.442	53
<b>40372-30CO</b>	<b>USUB</b>	48	23 1/4	45 1/4	30 1/2	—	0.887	1.442	54.5

\* Refer to page 253 for accurate COM calculations/ Référez-vous à la page 253 pour des calculs précis de COM

# Upright

T  
A



30408-CO DSNB

**BENCH**

(short version)

Distressed solid wood seat

Metal and wood colors shown/ Couleurs de métal et de bois montrées : Harley (51)/ Stone dust (89)

**BANC**

(version courte)

Siège en bois massif usé



30408-CO USNB

**BENCH**

(short version)

Upholstered seat

Metal color shown/ Couleur de métal montrée : Harley (51)

**BANC**

(version courte)

Siège rembourré



30410-CO DSNB

**BENCH**

(long version)

Distressed solid wood seat

Metal and wood colors shown/ Couleurs de métal et de bois montrées : Harley (51)/ Stone dust (89)

**BANC**

(version longue)

Siège en bois massif usé



30410-CO USNB

**BENCH**

(long version)

Upholstered seat

Metal color shown/ Couleur de métal montrée : Harley (51)

**BANC**

(version longue)

Siège rembourré

## MEASUREMENTS / MESURES

		W/L in/ po	D/P in/ po	H in/ po	S in/ po	A in/ po	COM <sub>S</sub> * yd/ vg	COM <sub>BR</sub> * yd/ vg	W/P lb
30408-CO	DSNB	44	15	17 5/8	17 5/8	—	—	—	35.5
30408-CO	USNB	44	15	18 7/8	18 7/8	—	0.75	—	27.5
30410-CO	DSNB	60	15	17 5/8	17 5/8	—	—	—	47
30410-CO	USNB	60	15	18 7/8	18 7/8	—	1	—	35.5

\* Refer to page 253 for accurate COM calculations/ Référez-vous à la page 253 pour des calculs précis de COM



30409-CO DSNB

**BENCH**

(short version)

Distressed solid wood seat

Metal and wood colors shown/ *Couleurs de métal et de bois montrées* : Magnetite (24)/ Stone dust (89)

**BANC**

(version courte)

*Siège en bois massif usé*



30409-CO USNB

**BENCH**

(short version)

Upholstered seat

Metal color shown/ *Couleur de métal montrée* : Magnetite (24)

**BANC**

(version courte)

*Siège rembourré*



30419-CO DSNB

**BENCH**

(long version)

Distressed solid wood seat

Metal and wood colors shown/ *Couleurs de métal et de bois montrées* : Magnetite (24)/ Stone dust (89)

**BANC**

(version longue)

*Siège en bois massif usé*



30419-CO USNB

**BENCH**

(long version)

Upholstered seat

Metal color shown/ *Couleur de métal montrée* : Magnetite (24)

**BANC**

(version longue)

*Siège rembourré*

**MEASUREMENTS / MESURES**

		W/L in/ po	D/P in/ po	H in/ po	S in/ po	A in/ po	COM <sub>s</sub> * yd/ vg	COM <sub>BR</sub> * yd/ vg	W/P lb
30409-CO	DSNB	44	15	17 1/2	17 1/2	—	—	—	33.5
30409-CO	USNB	44	15	18 7/8	18 7/8	—	0.75	—	25.5
30419-CO	DSNB	60	15	17 1/2	17 1/2	—	—	—	43.5
30419-CO	USNB	60	15	18 7/8	18 7/8	—	1	—	32

\* Refer to page 253 for accurate COM calculations/ *Référez-vous à la page 253 pour des calculs précis de COM*

# Malloy

T  
A

Compatible tabletop  
Dessus de table compatible



**90492-CO**  
20" x 20" x 1 1/16"



**NEW / NOUVEAU**

50266-CO

**END TABLE BASE**

Top not included

**BASE DE TABLE  
DE BOUT**

Dessus de table non inclus

Metal color shown / Couleur de métal montrée : Metallo (57)

**STEEL TABLE BASE MEASUREMENTS (WITHOUT TOP)**  
**MESURES DE BASE DE TABLE EN MÉTAL (SANS DESSUS DE TABLE)**

	<b>W/L</b> in/po	<b>D/P</b> in/po	<b>H</b> in/po	<b>W/P</b> lb
<b>50266-CO</b>	19 1/4	19 1/4	20 1/2	19.5

Compatible tabletops  
*Dessus de table compatibles*



**90851-CO**  
 28" x 48" x 1 1/16"



**93428-CO**  
 28" x 48" x 1 1/16"

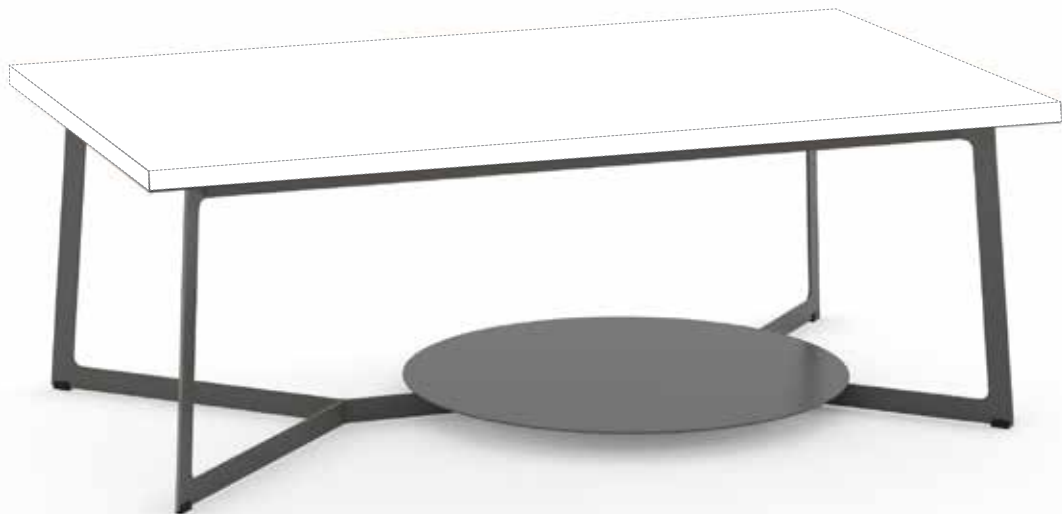

**NEW / NOUVEAU**

**50366-CO**

**COFFEE TABLE BASE**      **BASE DE TABLE À CAFÉ**

Top not included      *Dessus de table non inclus*

Metal color shown / *Couleur de métal montrée* : Metallo (57)

**STEEL TABLE BASE MEASUREMENTS (WITHOUT TOP)**  
**MESURES DE BASE DE TABLE EN MÉTAL (SANS DESSUS DE TABLE)**

	<b>W/L</b> in./po	<b>D/P</b> in./po	<b>H</b> in./po	<b>W/P</b> lb
<b>50366-CO</b>	45 1/4	25 1/4	16 1/2	28.5



# Malloy

T  
A

Compatible tabletops  
Dessus de table compatibles



**90406-CO**  
36" dia



**93406-CO**  
36" dia

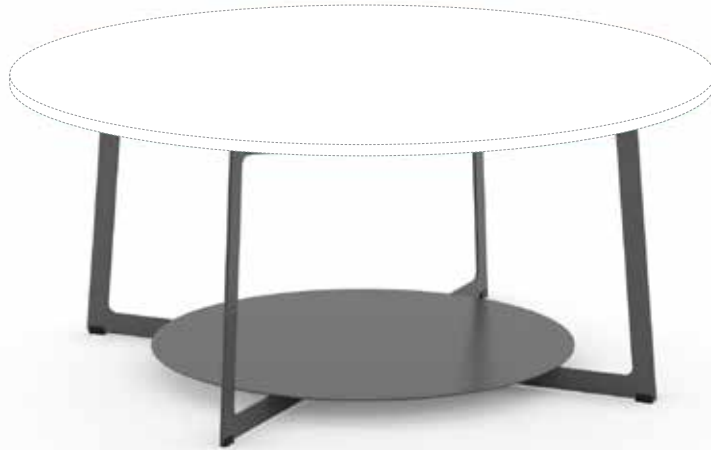

**NEW / NOUVEAU**

50466-CO

**COFFEE TABLE BASE**

Top not included

**BASE DE TABLE À CAFÉ**

Dessus de table non inclus

Metal color shown / Couleur de métal montrée : Metallo (57)

**STEEL TABLE BASE MEASUREMENTS (WITHOUT TOP)**  
**MESURES DE BASE DE TABLE EN MÉTAL (SANS DESSUS DE TABLE)**

	W/L in/po	D/P in/po	H in/po	W/P lb
<b>50466-CO</b>	25 1/4	25 1/4	16 1/2	24.5

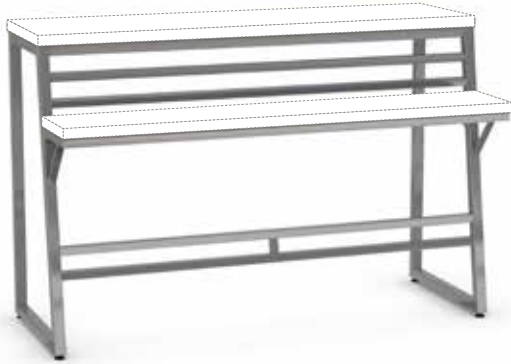

**NEW / NOUVEAU**

50464-CO

**LIVING ROOM ISLAND  
BASE**

(short version)

For a distressed solid wood  
tabletop, order 90494-CO

**BASE D'ÎLOT DE SALON**

(version courte)

Pour un dessus de table en  
bois massif usé, commander  
un 90494-CO

Metal color shown / Couleur de métal montrée : Magnetite (24)

Distressed Solid Wood Tabletops  
Dessus de table en bois massif usé

**90494-CO**

54" x 15" x 1 1/16"

54" x 8 3/4" x 1 1/16"

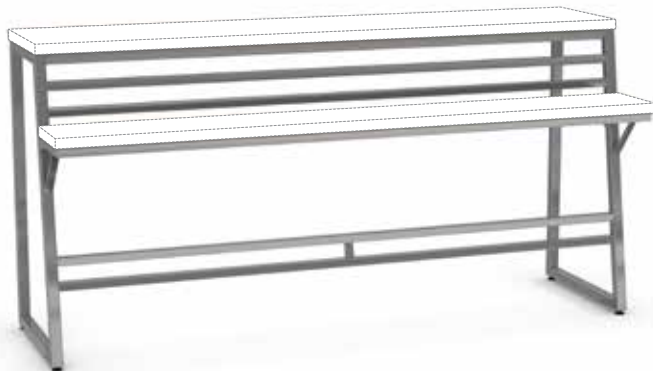

**NEW / NOUVEAU**

50764-CO

**LIVING ROOM ISLAND  
BASE**

(long version)

For a distressed solid wood  
tabletop, order 90497-CO

**BASE D'ÎLOT DE SALON**

(version longue)

Pour un dessus de table en  
bois massif usé, commander  
un 90497-CO

Metal color shown / Couleur de métal montrée : Magnetite (24)

Distressed Solid Wood Tabletops  
Dessus de table en bois massif usé

**90497-CO**

72" x 15" x 1 1/16"

72" x 8 3/4" x 1 1/16"



**STEEL TABLE BASE MEASUREMENTS (WITHOUT TOP)**  
**MESURES DE BASE DE TABLE EN MÉTAL (SANS DESSUS DE TABLE)**

	W/L in/po	D/P in/po	H in/po	W/P lb
<b>50464-CO</b>	53 3/4	24 3/4	34 7/8	29
<b>50764-CO</b>	71 3/4	24 3/4	34 7/8	38

# Crawford

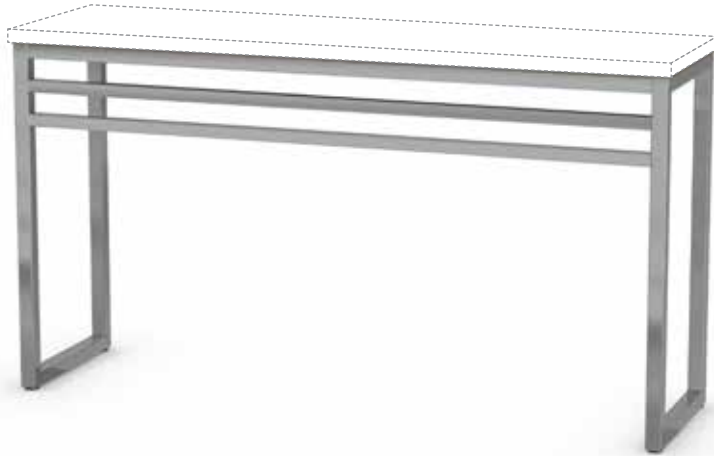

50164-CO

**CONSOLE TABLE BASE**  
(For 54" x 15" tabletop not included)  
For a distressed solid wood tabletop, order 90491

**BASE DE TABLE CONSOLE**  
(Pour un dessus de table 54" x 15" non inclus)  
Pour un dessus de table en bois massif usé, commander un 90491

Metal color shown/Couleur de métal montrée : Magnétite (24)

Distressed Solid Wood Tabletops Available  
Dessus de table en bois massif usé disponibles

**90491-CO**  
54" x 15" x 1 1/16"

**90492-CO**  
20" x 20" x 1 1/16"

**90493-CO**  
48" x 23 3/4" x 1 1/16"



50264-CO

**END TABLE BASE**  
(For 20" x 20" tabletop not included)  
For a distressed solid wood tabletop, order 90492

**BASE DE TABLE DE BOUT**  
(Pour un dessus de table 20" x 20" non inclus)  
Pour un dessus de table en bois massif usé, commander un 90492

Metal color shown/Couleur de métal montrée : Magnétite (24)



50364-CO

**COFFEE TABLE BASE**  
(For 48" x 23 3/4" tabletop not included)  
For a distressed solid wood tabletop, order 90493

**BASE DE TABLE À CAFÉ**  
(Pour un dessus de table 48" x 23 3/4" non inclus)  
Pour un dessus de table en bois massif usé, commander un 90493

Metal color shown/Couleur de métal montrée : Magnétite (24)

## STEEL TABLE BASE MEASUREMENTS (WITHOUT TOP) MESURES DE BASE DE TABLE EN MÉTAL (SANS DESSUS DE TABLE)

	W/L in/po	D/P in/po	H in/po	W/P lb
<b>50164-CO</b>	53 3/4	14 3/4	28 7/8	19.5
<b>50264-CO</b>	19 3/4	19 3/4	20 7/8	12.5
<b>50364-CO</b>	47 3/4	23 1/2	16 7/8	17.5

**NEW / NOUVEAU**

50465-CO

**LIVING ROOM ISLAND  
BASE**

(short version)

For a distressed solid wood  
tabletop, order 90494-CO

**BASE D'ÎLOT DE SALON**  
(version courte)

Pour un dessus de table en  
bois massif usé, commander  
un 90494-CO

Metal color shown / Couleur de métal montrée : Harley (51)



Distressed Solid Wood Tabletops  
Dessus de table en bois massif usé

**90494-CO**

54" x 15" x 1 1/16"

54" x 8 3/4" x 1 1/16"



**NEW / NOUVEAU**

50765-CO

**LIVING ROOM ISLAND  
BASE**

(long version)

For a distressed solid wood  
tabletop, order 90497-CO

**BASE D'ÎLOT DE SALON**  
(version longue)

Pour un dessus de table en  
bois massif usé, commander  
un 90497-CO

Metal color shown / Couleur de métal montrée : Harley (51)

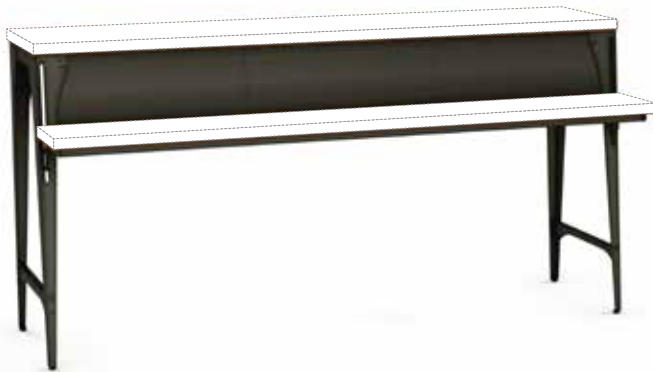

Distressed Solid Wood Tabletops  
Dessus de table en bois massif usé

**90497-CO**

72" x 15" x 1 1/16"

72" x 8 3/4" x 1 1/16"



**STEEL TABLE BASE MEASUREMENTS (WITHOUT TOP)**  
**MESURES DE BASE DE TABLE EN MÉTAL (SANS DESSUS DE TABLE)**

	W/L in/po	D/P in/po	H in/po	W/P lb
<b>50465-CO</b>	53 3/4	24	34 7/8	38
<b>50765-CO</b>	71 3/4	24	34 7/8	42

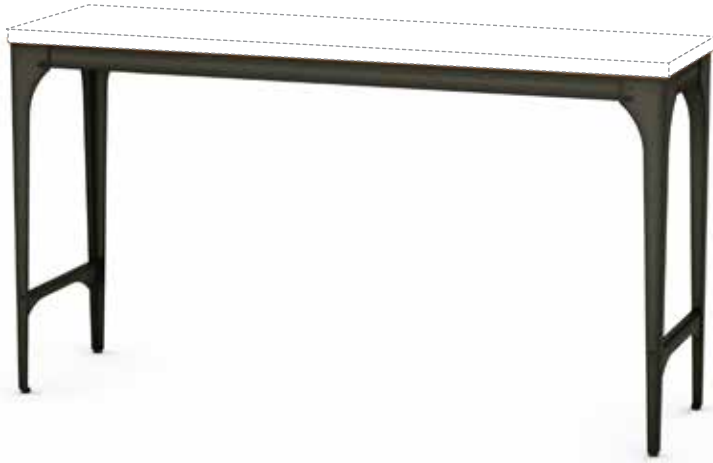

50165-CO

**CONSOLE TABLE BASE**  
(For 54" x 15" tabletop not included)  
For a distressed solid wood tabletop, order 90491

**BASE DE TABLE CONSOLE**  
(Pour un dessus de table 54" x 15" non inclus)  
Pour un dessus de table en bois massif usé, commander un 90491

Metal color shown/Couleur de métal montrée : Harley (51)

Distressed Solid Wood Tabletops Available  
*Dessus de table en bois massif usé disponibles*

**90491-CO**  
54" x 15" x 1 1/16"

**90492-CO**  
20" x 20" x 1 1/16"

**90493-CO**  
48" x 23 3/4" x 1 1/16"



50265-CO

**END TABLE BASE**  
(For 20" x 20" tabletop not included)  
For a distressed solid wood tabletop, order 90492

**BASE DE TABLE DE BOUT**  
(Pour un dessus de table 20" x 20" non inclus)  
Pour un dessus de table en bois massif usé, commander un 90492

Metal color shown/Couleur de métal montrée : Harley (51)



50365-CO

**COFFEE TABLE BASE**  
(For 48" x 23 3/4" tabletop not included)  
For a distressed solid wood tabletop, order 90493

**BASE DE TABLE À CAFÉ**  
(Pour un dessus de table 48" x 23 3/4" non inclus)  
Pour un dessus de table en bois massif usé, commander un 90493

Metal color shown/Couleur de métal montrée : Harley (51)

**STEEL TABLE BASE MEASUREMENTS (WITHOUT TOP)**  
**MESURES DE BASE DE TABLE EN MÉTAL (SANS DESSUS DE TABLE)**

	W/L in/po	D/P in/po	H in/po	W/P lb
<b>50165-CO</b>	53 3/4	14 3/4	28 7/8	17.5
<b>50265-CO</b>	19 3/4	19 3/4	20 7/8	14
<b>50365-CO</b>	47 3/4	23 1/2	16 7/8	15



21145-CO

**SHELVING UNIT**

Metal and distressed solid wood

Metal and wood colors shown/ Couleurs de métal et de bois montrées : Oxidado (52)/Toasty (87)

**ÉTAGÈRE**

Métal et bois massif usé

51145-CO

**FREESTANDING UNIT WITH TABLE**

Metal and distressed solid wood

Metal and wood colors shown/ Couleurs de métal et de bois montrées : Oxidado (52)/Toasty (87)

**UNITÉ AUTOPORTANTE AVEC TABLE**

Métal et bois massif usé

**MEASUREMENTS / MESURES**

	W/L in/ po	D/P in/ po	H in/ po	W/P lb
<b>21145-CO</b>	37 7/8	16	72 1/4	125.5
<b>51145-CO</b>	37 7/8	61 1/4	72 1/4	154.5





Back view / Vue arrière

30237-CO USUB

**ARMCHAIR**  
Upholstered seat, backrest  
and armrests

**CHAISE AVEC  
APPUIS-BRAS**  
Siège, dossier et appuis-bras  
rembourrés

Metal color shown / Couleur de métal montrée : Cobrizo (75)

**MEASUREMENTS / MESURES**

		W/L in/po	D/P in/po	H in/po	S in/po	A in/po	COM <sub>S</sub> * yd/vg	COM <sub>BR</sub> * yd/vg	COM <sub>A</sub> * yd/vg	W/P lb
<b>30237-CO</b>	<b>USUB</b>	24	23 1/2	32	18 3/8	24	0.495	0.382	0.053	26

\* Refer to page 253 for accurate COM calculations / Référez-vous à la page 253 pour des calculs précis de COM



Side view / *Vue de côté*



Back view / *Vue arrière*



30425-CO USUB

**LOUNGE CHAIR**

Upholstered seat and backrest with metal armrests

**FAUTEUIL D'ACCENT**

*Siège et dossier rembourrés avec appuis-bras en métal*

Metal color shown / *Couleur de métal montrée* : Cobrizo (75)

**MEASUREMENTS / MESURES**

	W/L in/po	D/P in/po	H in/po	S in/po	A in/po	COM <sub>S</sub> * yd/vg	COM <sub>BR</sub> * yd/vg	W/P lb
<b>30425-CO USUB</b>	31	28 1/2	30	16 3/4	25	1.056	0.831	32.5

\* Refer to page 253 for accurate COM calculations / *Référez-vous à la page 253 pour des calculs précis de COM*

# Singapore



Side view / Vue de côté



Back view / Vue arrière



30435-CO USUB

## LOUNGE CHAIR

Swivel-tilt  
Upholstered seat  
and backrest

## FAUTEUIL D'ACCENT

Bascule et pivote  
Siège et dossier  
rembourrés

Metal color shown / Couleur de métal montrée : Titanium (56)

### MEASUREMENTS / MESURES

	W/L in/po	D/P in/po	H in/po	S in/po	A in/po	COM <sup>s*</sup> yd/vg	COM <sup>BR*</sup> yd/vg	W/P lb
<b>30435-CO USUB</b>	30	26	31 3/4	16 1/8	—	0.796	1.141	58

\* Refer to page 253 for accurate COM calculations / Référez-vous à la page 253 pour des calculs précis de COM



50570-CO

**SQUARE TABLE BASE**

Includes adjustable glides  
Top not included

Metal color shown / Couleur de métal montrée : Magnetite (24)

**BASE DE TABLE CARRÉE**

Avec glisseurs ajustables  
Dessus de table non inclus



50580-CO

**RECTANGULAR TABLE BASE**

Includes adjustable glides  
Top not included

Metal color shown / Couleur de métal montrée : Magnetite (24)

**BASE DE TABLE RECTANGULAIRE**

Avec glisseurs ajustables  
Dessus de table non inclus

Square table base / Base de table carrée

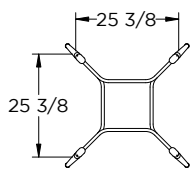

Top view / Vue de dessus

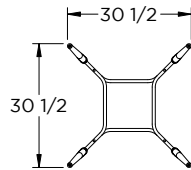

Bottom view / Vue de dessous

Rectangular table base / Base de table rectangulaire

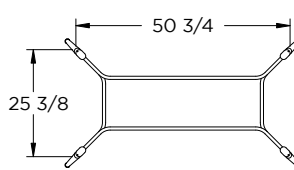

Top view / Vue de dessus

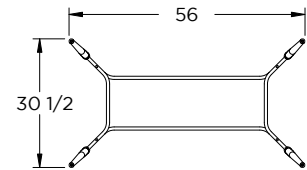

Bottom view / Vue de dessous

**STEEL TABLE BASE MEASUREMENTS (WITHOUT TOP)**  
**MESURES DE BASE DE TABLE EN MÉTAL (SANS DESSUS DE TABLE)**

	W/L in/po	D/P in/po	H in/po	W/P lb
<b>50570-CO</b>	30 1/2	30 1/2	29 1/2	17
<b>50580-CO</b>	30 1/2	56	29 1/2	22

See the list of compatible tabletops on pages 223 225, 228 and 229 / Voir la liste des dessus de table compatibles aux pages 223, 225, 228 et 229

# Bennington



50660-CO

**TABLE BASE**

Top not included

Metal color shown / Couleur de métal montrée : Metallo (57)

**BASE DE TABLE**

Dessus de table non inclus

50660-36CO

**TABLE BASE (COUNTER HEIGHT)**

Top not included

**BASE DE TABLE (HAUTEUR COMPTOIR)**

Dessus de table non inclus

50660-42CO

**TABLE BASE (BAR HEIGHT)**

Top not included

**BASE DE TABLE (HAUTEUR BAR)**

Dessus de table non inclus

Metal color shown / Couleur de métal montrée : Metallo (57)

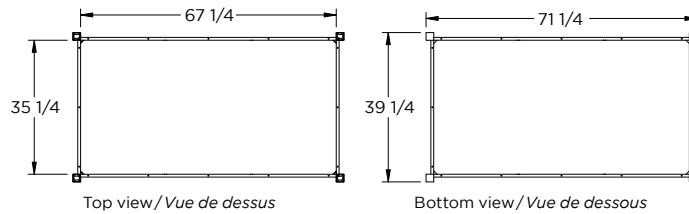

**STEEL TABLE BASE MEASUREMENTS (WITHOUT TOP)**  
**MESURES DE BASE DE TABLE EN MÉTAL (SANS DESSUS DE TABLE)**

	W/L in/po	D/P in/po	H in/po	W/P lb
<b>50660-CO</b>	39 1/4	71 1/4	28 7/8	40.5
<b>50660-36CO</b>	39 1/4	71 1/4	34 7/8	43
<b>50660-42CO</b>	39 1/4	71 1/4	40 7/8	47

See the list of compatible tabletops on pages 223, 225, 228 and 229 / Voir la liste des dessus de table compatibles aux pages 223, 225, 228 et 229

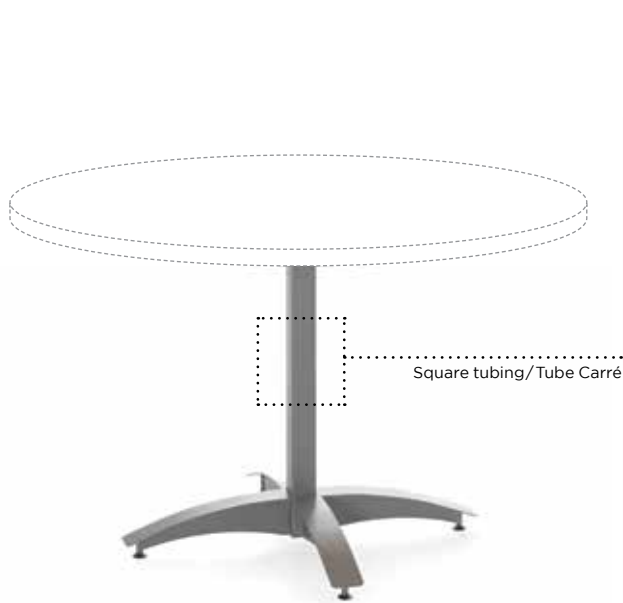

50551-CO

**TABLE BASE**

Includes adjustable glides  
Top not included

Metal color shown/ Couleur de métal montrée : Titanium (56)

**BASE DE TABLE**

Avec glisseurs ajustables  
Dessus de table non inclus



50551-36CO

**TABLE BASE  
(COUNTER HEIGHT)**

Includes adjustable glides  
Top not included

**BASE DE TABLE  
(HAUTEUR COMPTOIR)**

Avec glisseurs ajustables  
Dessus de table non inclus

50551-42CO

**TABLE BASE  
(BAR HEIGHT)**

Includes adjustable glides  
Top not included

**BASE DE TABLE  
(HAUTEUR BAR)**

Avec glisseurs ajustables  
Dessus de table non inclus

Metal color shown/ Couleur de métal montrée : Titanium (56)

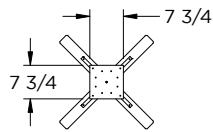

Top view/ Vue de dessus

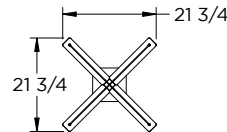

Bottom view/ Vue de dessous

**STEEL TABLE BASE MEASUREMENTS (WITHOUT TOP)  
MESURES DE BASE DE TABLE EN MÉTAL (SANS DESSUS DE TABLE)**

	W/L in/po	D/P in/po	H in/po	W/P lb
<b>50551-CO</b>	21 3/4	21 3/4	29	14
<b>50551-36CO</b>	21 3/4	21 3/4	35	16
<b>50551-42CO</b>	21 3/4	21 3/4	41	17.5

See the list of compatible tabletops on pages 223 225, 228 and 229 / Voir la liste des dessus de table compatibles aux pages 223, 225, 228 et 229



# Burton



50557-CO

**TABLE BASE**

Top not included

**BASE DE TABLE**

Dessus de table non inclus

Metal color shown / Couleur de métal montrée : Magnetite (24)

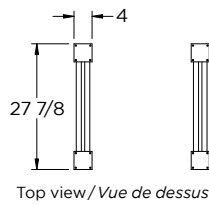

Top view / Vue de dessus

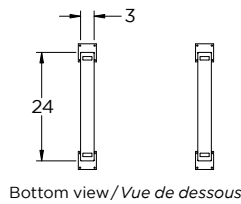

Bottom view / Vue de dessous

**STEEL TABLE BASE MEASUREMENTS (WITHOUT TOP)**  
**MESURES DE BASE DE TABLE EN MÉTAL (SANS DESSUS DE TABLE)**

	W/L in/po	D/P in/po	H in/po	W/P lb
<b>50557-CO</b>	27 7/8	4	29 3/8	25.5

See the list of compatible tabletops on pages 223, 225, 228 and 229 / Voir la liste des dessus de table compatibles aux pages 223, 225, 228 et 229



50696-CO

**TABLE BASE**

Top not included

**BASE DE TABLE**

*Dessus de table non inclus*

Metal color shown/ *Couleur de métal montrée* : Magnetite (24)

Not available in Snow (63) metal color  
*Non disponible dans la couleur de métal Snow (63)*



50796-CO

**TABLE BASE  
(COUNTER HEIGHT)**

Top not included

**BASE DE TABLE  
(HAUTEUR COMPTOIR)**

*Dessus de table non inclus*

50896-CO

**TABLE BASE  
(BAR HEIGHT)**

Top not included

**BASE DE TABLE  
(HAUTEUR BAR)**

*Dessus de table non inclus*

Metal color shown/ *Couleur de métal montrée* : Titanium (56)

Not available in Snow (63) metal color  
*Non disponible dans la couleur de métal Snow (63)*

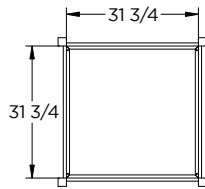

Top view/ *Vue de dessus*

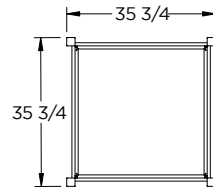

Bottom view/ *Vue de dessous*

**STEEL TABLE BASE MEASUREMENTS (WITHOUT TOP)**  
**MESURES DE BASE DE TABLE EN MÉTAL (SANS DESSUS DE TABLE)**

	W/L in/po	D/P in/po	H in/po	W/P lb
<b>50696-CO</b>	35 3/4	35 3/4	29 5/8	30.5
<b>50796-CO</b>	35 3/4	35 3/4	35 5/8	42
<b>50896-CO</b>	35 3/4	35 3/4	41 5/8	46

See the list of compatible tabletops on pages 223 225, 228 and 229 / *Voir la liste des dessus de table compatibles aux pages 223, 225, 228 et 229*

# Carbon



50662-CO

**TABLE BASE**

Top not included

Metal color shown/Couleur de métal montrée : Titanium (56)

**BASE DE TABLE**

Dessus de table non inclus

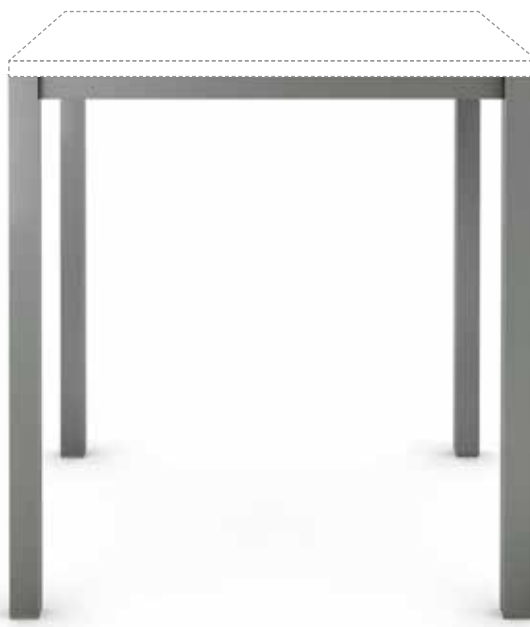

50662-36CO

**TABLE BASE  
(COUNTER HEIGHT)**

Top not included

50662-42CO

**TABLE BASE  
(BAR HEIGHT)**

Top not included

Metal color shown/Couleur de métal montrée : Titanium (56)

**BASE DE TABLE  
(HAUTEUR COMPTOIR)**

Dessus de table non inclus

**BASE DE TABLE  
(HAUTEUR BAR)**

Dessus de table non inclus

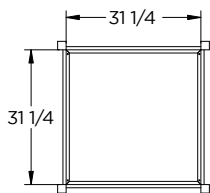

Top view/Vue de dessus

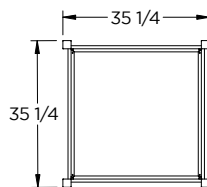

Bottom view/Vue de dessous

**STEEL TABLE BASE MEASUREMENTS (WITHOUT TOP)**  
**MESURES DE BASE DE TABLE EN MÉTAL (SANS DESSUS DE TABLE)**

	W/L in/po	D/P in/po	H in/po	W/P lb
50662-CO	35 1/4	35 1/4	28 7/8	28
50662-36CO	35 1/4	35 1/4	34 7/8	30
50662-42CO	35 1/4	35 1/4	40 7/8	34

See the list of compatible tabletops on pages 223, 225, 228 and 229 / Voir la liste des dessus de table compatibles aux pages 223, 225, 228 et 229



**NEW / NOUVEAU**

50507-CO

**TABLE BASE**

Top not included

Metal color shown / Couleur de métal montrée : —

**BASE DE TABLE**

Dessus de table non inclus



**NEW / NOUVEAU**

50507-38CO

**TABLE BASE (COUNTER HEIGHT)**

Top not included

Metal color shown / Couleur de métal montrée : Metallo (57)

**BASE DE TABLE (HAUTEUR COMPTOIR)**

Dessus de table non inclus

**NEW / NOUVEAU**

50507-42CO

**TABLE BASE (BAR HEIGHT)**

Top not included

**BASE DE TABLE (HAUTEUR BAR)**

Dessus de table non inclus

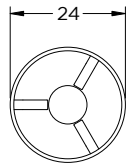

Top view / Vue de dessus

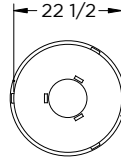

Bottom view / Vue de dessous

**STEEL TABLE BASE MEASUREMENTS (WITHOUT TOP)**  
**MESURES DE BASE DE TABLE EN MÉTAL (SANS DESSUS DE TABLE)**

	W/L in/po	D/P in/po	H in/po	W/P lb
50507-CO	24	24	29 1/2	34
50507-38CO	24	24	37 1/2	35,5
50507-42CO	24	24	41 1/2	37

See the list of compatible tabletops on pages 223, 225, 228 and 229 / Voir la liste des dessus de table compatibles aux pages 223, 225, 228 et 229

# Dalia XL



**NEW / NOUVEAU**

50547-CO

**TABLE BASE  
(TABLE HEIGHT)**

Top not included

**BASE DE TABLE  
(HAUTEUR TABLE)**

Dessus de table non inclus

Metal color shown / Couleur de métal montrée : Black coral / Noir corail (25)

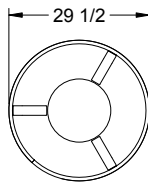

Top view / Vue de dessus

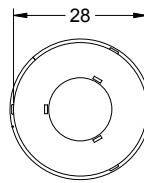

Bottom view / Vue de dessous

**STEEL TABLE BASE MEASUREMENTS (WITHOUT TOP)**  
**MESURES DE BASE DE TABLE EN MÉTAL (SANS DESSUS DE TABLE)**

	W/L in/po	D/P in/po	H in/po	W/P lb
<b>50547-CO</b>	29 1/2	29 1/2	28 7/8	46

See the list of compatible tabletops on pages 223, 225, 228 and 229 / Voir la liste des dessus de table compatibles aux pages 223, 225, 228 et 229



## 50634-CO

### TABLE BASE

Includes adjustable glides  
Top not included

Metal color shown/ Couleur de métal montrée : Titanium (56)

### BASE DE TABLE

Avec glisseurs ajustables  
Dessus de table non inclus



## 50734-CO

### TABLE BASE (COUNTER HEIGHT)

Includes adjustable glides  
Top not included

## 50834-CO

### TABLE BASE (BAR HEIGHT)

Includes adjustable glides  
Top not included

Metal color shown/ Couleur de métal montrée : Titanium (56)

### BASE DE TABLE (HAUTEUR COMPTOIR)

Avec glisseurs ajustables  
Dessus de table non inclus

### BASE DE TABLE (HAUTEUR BAR)

Avec glisseurs ajustables  
Dessus de table non inclus

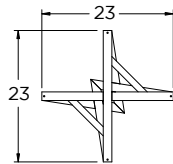

Top view / Vue de dessus

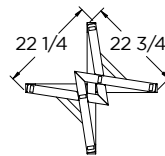

Bottom view / Vue de dessous

## STEEL TABLE BASE MEASUREMENTS (WITHOUT TOP) MESURES DE BASE DE TABLE EN MÉTAL (SANS DESSUS DE TABLE)

	W/L in/po	D/P in/po	H in/po	W/P lb
<b>50634-CO</b>	22 1/4	22 3/4	28 1/2	21
<b>50734-CO</b>	22 1/4	22 3/4	36 1/2	24
<b>50834-CO</b>	22 1/4	22 3/4	40 1/2	25.5

See the list of compatible tabletops on pages 223, 225, 228 and 229 / Voir la liste des dessus de table compatibles aux pages 223, 225, 228 et 229



# Eliot



**NEW/NOUVEAU**

**50071-PACO**

**SET OF 4 LEGS**

Top not included

**JEU DE 4 PATTES**

Dessus de table non inclus

Metal color shown / Couleur de métal montrée : Titanium (56)

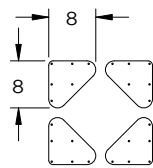

Top view / Vue de dessus

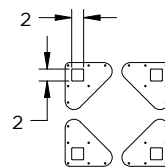

Bottom view / Vue de dessous

**STEEL TABLE BASE MEASUREMENTS (WITHOUT TOP)**  
**MESURES DE BASE DE TABLE EN MÉTAL (SANS DESSUS DE TABLE)**

	W/L in/po	D/P in/po	H in/po	W/P lb
<b>50071-PACO</b>	2	2	29	25

See the list of compatible tabletops on pages 223, 225, 228 and 229 / Voir la liste des dessus de table compatibles aux pages 223, 225, 228 et 229



**NEW / NOUVEAU**

50536-CO

**TABLE BASE**

Top not included

Metal color shown / Couleur de métal montrée : Dayglam (53)

**BASE DE TABLE**

Dessus de table non inclus



**NEW / NOUVEAU**

50536-36CO

**TABLE BASE  
(COUNTER HEIGHT)**

Top not included

**BASE DE TABLE  
(HAUTEUR COMPTOIR)**

Dessus de table non inclus

**NEW / NOUVEAU**

50536-42CO

**TABLE BASE  
(BAR HEIGHT)**

Top not included

Metal color shown / Couleur de métal montrée : Dayglam (53)

**BASE DE TABLE  
(HAUTEUR BAR)**

Dessus de table non inclus

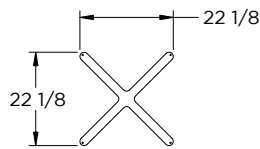

Top view / Vue de dessus

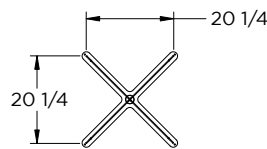

Bottom view / Vue de dessous

**STEEL TABLE BASE MEASUREMENTS (WITHOUT TOP)  
MESURES DE BASE DE TABLE EN MÉTAL (SANS DESSUS DE TABLE)**

	W/L in./po	D/P in./po	H in./po	W/P lb
<b>50536-CO</b>	22 1/8	22 1/8	28 5/8	36
<b>50536-36CO</b>	22 1/8	22 1/8	34 5/8	41
<b>50536-42CO</b>	22 1/8	22 1/8	40 5/8	46.5

See the list of compatible tabletops on pages 223, 225, 228 and 229 / Voir la liste des dessus de table compatibles aux pages 223, 225, 228 et 229

# Harrison



50668-CO

**TABLE BASE**

Top not included

Metal color shown / Couleur de métal montrée : Titanium (56)

**BASE DE TABLE**

Dessus de table non inclus

50668-36CO

**TABLE BASE  
(COUNTER HEIGHT)**

Top not included

**BASE DE TABLE  
(HAUTEUR COMPTOIR)**

Dessus de table non inclus

50668-42CO

**TABLE BASE  
(BAR HEIGHT)**

Top not included

**BASE DE TABLE  
(HAUTEUR BAR)**

Dessus de table non inclus

Metal color shown / Couleur de métal montrée : Titanium (56)

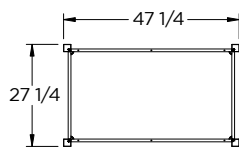

Top view / Vue de dessus

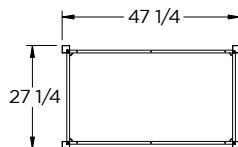

Bottom view / Vue de dessous

**STEEL TABLE BASE MEASUREMENTS (WITHOUT TOP)**  
**MESURES DE BASE DE TABLE EN MÉTAL (SANS DESSUS DE TABLE)**

	W/L in/po	D/P in/po	H in/po	W/P lb
<b>50668-CO</b>	27 1/4	47 1/4	28 7/8	27.5
<b>50668-36CO</b>	27 1/4	47 1/4	34 7/8	29.5
<b>50668-42CO</b>	27 1/4	47 1/4	40 7/8	33.5

See the list of compatible tabletops on pages 223, 225, 228 and 229 / Voir la liste des dessus de table compatibles aux pages 223, 225, 228 et 229



50550-CO

**TABLE BASE**

Includes adjustable glides  
Top not included

Metal color shown/ Couleur de métal montrée : Metallo (57)

**BASE DE TABLE**

Avec glisseurs ajustables  
Dessus de table non inclus



50550-36CO

**TABLE BASE  
(COUNTER HEIGHT)**

Includes adjustable glides  
Top not included

50550-42CO

**TABLE BASE  
(BAR HEIGHT)**

Includes adjustable glides  
Top not included

Metal color shown/ Couleur de métal montrée : Metallo (57)

**BASE DE TABLE  
(HAUTEUR COMPTOIR)**

Avec glisseurs ajustables  
Dessus de table non inclus

**BASE DE TABLE  
(HAUTEUR BAR)**

Avec glisseurs ajustables  
Dessus de table non inclus

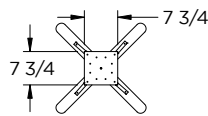

Top view/ Vue de dessus

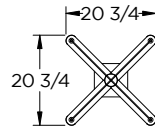

Bottom view/ Vue de dessous

**STEEL TABLE BASE MEASUREMENTS (WITHOUT TOP)  
MESURES DE BASE DE TABLE EN MÉTAL (SANS DESSUS DE TABLE)**

	W/L in/ po	D/P in/ po	H in/ po	W/P lb
<b>50550-CO</b>	20 3/4	20 3/4	29	13
<b>50550-36CO</b>	20 3/4	20 3/4	35	15
<b>50550-42CO</b>	20 3/4	20 3/4	41	16.5

See the list of compatible tabletops on pages 223 225, 228 and 229 / Voir la liste des dessus de table compatibles aux pages 223, 225, 228 et 229

# Kai



50609-CO

**TABLE BASE**

Top not included

Metal color shown/ Couleur de métal montrée : Metallo (57)

**BASE DE TABLE**

Dessus de table non inclus



50709-CO

**TABLE BASE (COUNTER HEIGHT)**

Top not included

**BASE DE TABLE (HAUTEUR COMPTOIR)**

Dessus de table non inclus

50809-CO

**TABLE BASE (BAR HEIGHT)**

Top not included

**BASE DE TABLE (HAUTEUR BAR)**

Dessus de table non inclus

Metal color shown/ Couleur de métal montrée : Metallo (57)

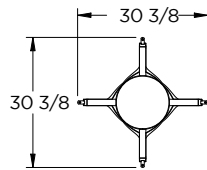

Top view/ Vue de dessus

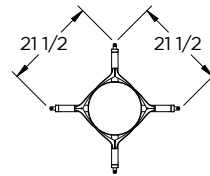

Bottom view/ Vue de dessous

**STEEL TABLE BASE MEASUREMENTS (WITHOUT TOP)**  
**MESURES DE BASE DE TABLE EN MÉTAL (SANS DESSUS DE TABLE)**

	W/L in/po	D/P in/po	H in/po	W/P lb
<b>50609-CO</b>	21 1/2	21 1/2	29 1/4	15.5
<b>50709-CO</b>	21 1/2	21 1/2	35 1/4	16.5
<b>50809-CO</b>	21 1/2	21 1/2	41 1/4	18.5

See the list of compatible tabletops on pages 223 225, 228 and 229 / Voir la liste des dessus de table compatibles aux pages 223, 225, 228 et 229



52553-CO

**TABLE BASE**

(with distressed solid wood beam)

Includes adjustable glides  
Top not included

**BASE DE TABLE**

(avec poutre en bois massif usé)

Avec glisseurs ajustables  
Dessus de table non inclus

Metal and wood colors shown / Couleurs de métal et bois montrées :  
Falcon (74) / Toasty (87)

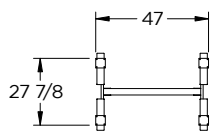

Top view / Vue de dessus

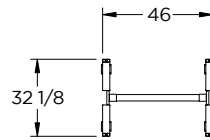

Bottom view / Vue de dessous

**STEEL TABLE BASE MEASUREMENTS (WITHOUT TOP)**  
**MESURES DE BASE DE TABLE EN MÉTAL (SANS DESSUS DE TABLE)**

	<b>W/L</b> in/po	<b>D/P</b> in/po	<b>H</b> in/po	<b>W/P</b> lb
<b>52553-CO</b>	32 1/8	47	29 1/4	26

See the list of compatible tabletops on pages 223, 225, 228 and 229 / Voir la liste des dessus de table compatibles aux pages 223, 225, 228 et 229



# Lidya



**NEW / NOUVEAU**

**50583-PACO**

**SET OF 4 LEGS**

Top not included

**JEU DE 4 PATTES**

Dessus de table non inclus

Metal color shown / Couleur de métal montrée : Black coral / Noir corail (25)

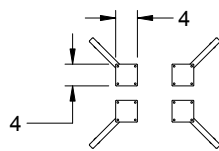

Top view / Vue de dessus

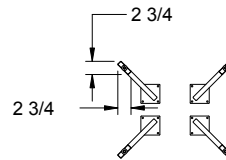

Bottom view / Vue de dessous

**STEEL TABLE BASE MEASUREMENTS (WITHOUT TOP)**  
**MESURES DE BASE DE TABLE EN MÉTAL (SANS DESSUS DE TABLE)**

	W/L in/po	D/P in/po	H in/po	W/P lb
<b>50583-PACO</b>	3	1	28 1/2	18

See the list of compatible tabletops on pages 223, 225, 228 and 229 / Voir la liste des dessus de table compatibles aux pages 223, 225, 228 et 229



50552-CO

**TABLE BASE  
(SHORT VERSION)**

Top not included

Metal colors shown/Couleurs de métal montrées : Harley (51)/Sun gold (27)

**BASE DE TABLE  
(VERSION COURTE)**

Dessus de table non inclus

50553-CO

**TABLE BASE  
(LONG VERSION)**

Top not included

Metal colors shown/Couleurs de métal montrées : Harley (51)/Sun gold (27)

**BASE DE TABLE  
(VERSION LONGUE)**

Dessus de table non inclus

Short version/Version courte

Long version/Version longue

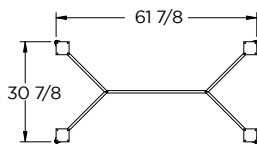

Top view/Vue de dessus

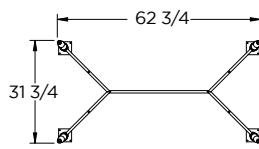

Bottom view/Vue de dessous

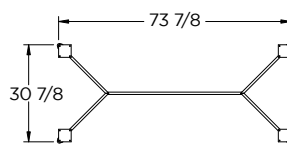

Top view/Vue de dessus

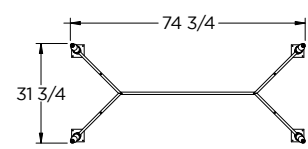

Bottom view/Vue de dessous

**STEEL TABLE BASE MEASUREMENTS (WITHOUT TOP)  
MESURES DE BASE DE TABLE EN MÉTAL (SANS DESSUS DE TABLE)**

	W/L in/po	D/P in/po	H in/po	W/P lb
50552-CO	31 3/4	62 3/4	29 1/4	26
50553-CO	31 3/4	74 3/4	29 1/4	27

See the list of compatible tabletops on pages 223 225, 228 and 229 / Voir la liste des dessus de table compatibles aux pages 223, 225, 228 et 229



50554-36CO

**TABLE BASE  
(COUNTER HEIGHT)**

Top not included

Metal colors shown/ Couleurs de métal montrées :  
Titanium (56)/Black coral/Noir corail (25)

**BASE DE TABLE  
(HAUTEUR COMPTOIR)**

Dessus de table non inclus



50554-42CO

**TABLE BASE  
(BAR HEIGHT)**

Top not included

Metal colors shown/ Couleurs de métal montrées :  
Dayglam (53)/Black coral/Noir corail (25)

**BASE DE TABLE  
(HAUTEUR BAR)**

Dessus de table non inclus

Counter height/ Hauteur comptoir

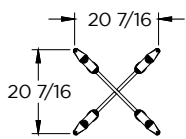

Top view/ Vue de dessus

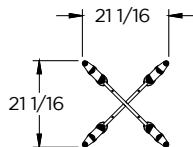

Bottom view/ Vue de dessous

Bar height/ Hauteur bar

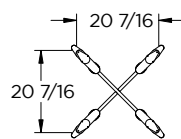

Top view/ Vue de dessus

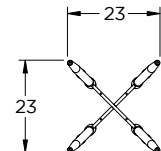

Bottom view/ Vue de dessous

**STEEL TABLE BASE MEASUREMENTS (WITHOUT TOP)  
MESURES DE BASE DE TABLE EN MÉTAL (SANS DESSUS DE TABLE)**

	W/L in/po	D/P in/po	H in/po	W/P lb
50554-36CO	21 1/2	21 1/2	35 1/2	19.5
50554-42CO	23	23	41 1/2	21.5

See the list of compatible tabletops on pages 223 225, 228 and 229 / Voir la liste des dessus de table compatibles aux pages 223, 225, 228 et 229

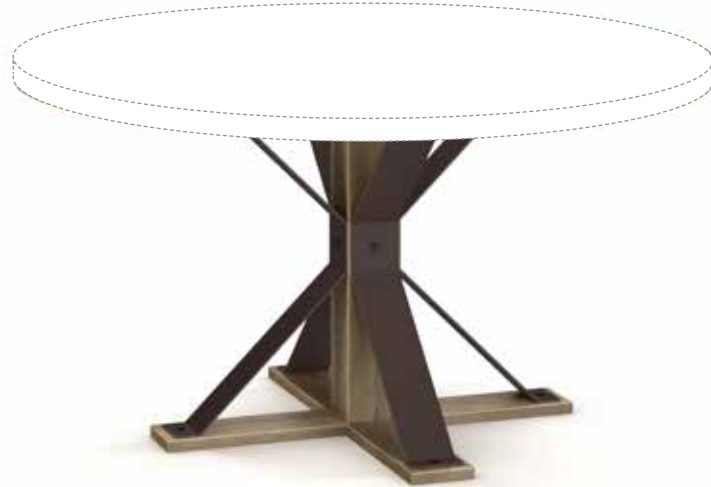

**NEW / NOUVEAU**

50538-CO

**TABLE BASE**

Top not included

**BASE DE TABLE**

Dessus de table non inclus

Metal and wood colors shown / Couleur de métal et de bois montrées :  
Oxidado (52) / Sand dust (86)

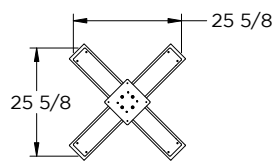

Top view / Vue de dessus

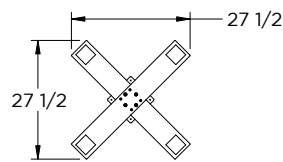

Bottom view / Vue de dessous

**STEEL TABLE BASE MEASUREMENTS (WITHOUT TOP)**  
**MESURES DE BASE DE TABLE EN MÉTAL (SANS DESSUS DE TABLE)**

	W/L in/po	D/P in/po	H in/po	W/P lb
<b>50538-CO</b>	34	34	29	39.5

See the list of compatible tabletops on pages 223 225, 228 and 229 / Voir la liste des dessus de table compatibles aux pages 223, 225, 228 et 229

# Moris



50571-CO

**SQUARE TABLE BASE**

Includes adjustable glides  
Top not included

Metal color shown / Couleur de métal montrée : Magnetite (24)

**BASE DE TABLE CARRÉE**

Avec glisseurs ajustables  
Dessus de table non inclus

50581-CO

**RECTANGULAR TABLE BASE**

Includes adjustable glides  
Top not included

Metal color shown / Couleur de métal montrée : Magnetite (24)

**BASE DE TABLE RECTANGULAIRE**

Avec glisseurs ajustables  
Dessus de table non inclus

Square table base / Base de table carrée

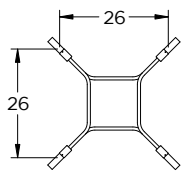

Top view / Vue de dessus

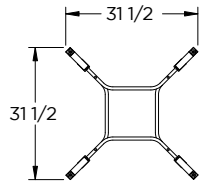

Bottom view / Vue de dessous

Rectangular table base / Base de table rectangulaire

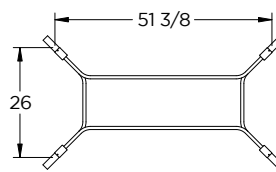

Top view / Vue de dessus

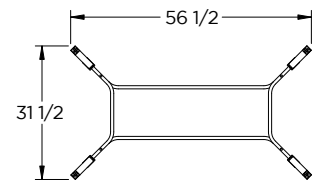

Bottom view / Vue de dessous

**STEEL TABLE BASE MEASUREMENTS (WITHOUT TOP)**  
**MESURES DE BASE DE TABLE EN MÉTAL (SANS DESSUS DE TABLE)**

	W/L in/po	D/P in/po	H in/po	W/P lb
50571-CO	31 1/2	31 1/2	29 1/2	19.5
50581-CO	31 1/2	56 1/2	29 1/2	24.5

See the list of compatible tabletops on pages 223, 225, 228 and 229 / Voir la liste des dessus de table compatibles aux pages 223, 225, 228 et 229



50667-CO

**TABLE BASE**

Top not included

Metal color shown / Couleur de métal montrée : Cobrizo (75)

**BASE DE TABLE**

Dessus de table non inclus

50667-36CO

**TABLE BASE (COUNTER HEIGHT)**

Top not included

**BASE DE TABLE (HAUTEUR COMPTOIR)**

Dessus de table non inclus

50667-42CO

**TABLE BASE (BAR HEIGHT)**

Top not included

**BASE DE TABLE (HAUTEUR BAR)**

Dessus de table non inclus

Metal color shown / Couleur de métal montrée : Cobrizo (75)

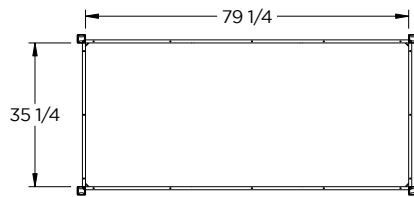

Top view / Vue de dessus

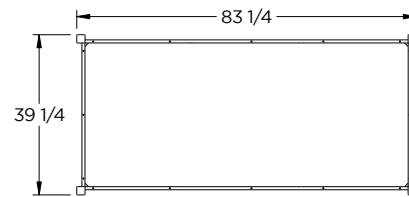

Bottom view / Vue de dessous

**STEEL TABLE BASE MEASUREMENTS (WITHOUT TOP)**  
**MESURES DE BASE DE TABLE EN MÉTAL (SANS DESSUS DE TABLE)**

	W/L in/po	D/P in/po	H in/po	W/P lb
<b>50667-CO</b>	39 1/4	83 1/4	28 7/8	42.5
<b>50667-36CO</b>	39 1/4	83 1/4	34 7/8	45
<b>50667-42CO</b>	39 1/4	83 1/4	40 7/8	49

See the list of compatible tabletops on pages 223, 225, 228 and 229 / Voir la liste des dessus de table compatibles aux pages 223, 225, 228 et 229



# Norcross



50563-CO

**TABLE BASE**

Includes adjustable glides  
Top not included

Metal color shown/ Couleur de métal montrée : Oxidado (52)

**BASE DE TABLE**

Avec glisseurs ajustables  
Dessus de table non inclus



50563-36CO

**TABLE BASE  
(COUNTER HEIGHT)**

Includes adjustable glides  
Top not included

**BASE DE TABLE  
(HAUTEUR COMPTOIR)**

Avec glisseurs ajustables  
Dessus de table non inclus

50563-42CO

**TABLE BASE  
(BAR HEIGHT)**

Includes adjustable glides  
Top not included

**BASE DE TABLE  
(HAUTEUR BAR)**

Avec glisseurs ajustables  
Dessus de table non inclus

Metal color shown/ Couleur de métal montrée : Harley (51)

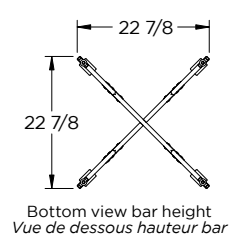
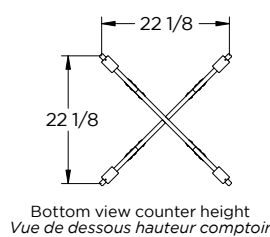
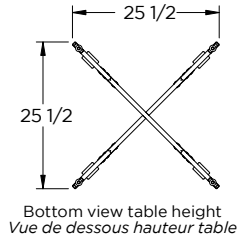
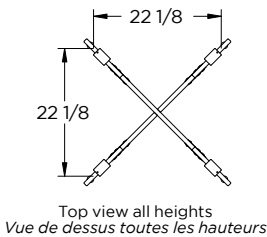

**STEEL TABLE BASE MEASUREMENTS (WITHOUT TOP)  
MESURES DE BASE DE TABLE EN MÉTAL (SANS DESSUS DE TABLE)**

	W/L in/po	D/P in/po	H in/po	W/P lb
50563-CO	25 1/2	25 1/2	29	13.5
50563-36CO	22 7/8	22 7/8	34 7/8	17
50563-42CO	22 1/8	22 1/8	40 7/8	18.5

See the list of compatible tabletops on pages 223 225, 228 and 229 / Voir la liste des dessus de table compatibles aux pages 223, 225, 228 et 229



50565-CO

**TABLE BASE  
(LONG VERSION)**

Top not included

Metal color shown / *Couleur de métal montrée* : Harley (51)

**BASE DE TABLE  
(VERSION LONGUE)**

*Dessus de table non inclus*

50565-36CO

**TABLE BASE  
(COUNTER HEIGHT-  
LONG VERSION)**

Top not included

**BASE DE TABLE  
(HAUTEUR COMPTOIR-  
VERSION LONGUE)**

*Dessus de table non inclus*

50565-42CO

**TABLE BASE  
(BAR HEIGHT-  
LONG VERSION)**

Top not included

**BASE DE TABLE  
(HAUTEUR BAR-  
VERSION LONGUE)**

*Dessus de table non inclus*

Metal color shown / *Couleur de métal montrée* : Metallo (57)

Table height / *Hauteur table*

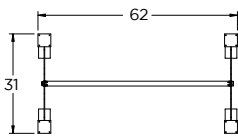

Top view / *Vue de dessus*

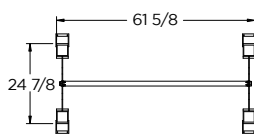

Bottom view / *Vue de dessous*

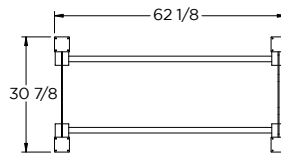

Top view / *Vue de dessus*

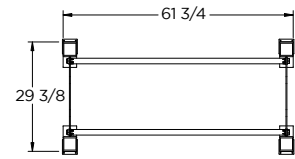

Bottom view / *Vue de dessous*

Counter and bar height / *Hauteur comptoir et bar*

**STEEL TABLE BASE MEASUREMENTS (WITHOUT TOP)**

**MESURES DE BASE DE TABLE EN MÉTAL (SANS DESSUS DE TABLE)**

	W/L in/po	D/P in/po	H in/po	W/P lb
50565-CO	31	62	29 1/4	51
50565-36CO	30 7/8	61 3/4	35 1/4	58
50565-42CO	30 7/8	61 3/4	41 1/4	68

See the list of compatible tabletops on pages 223, 225, 228 and 229 / *Voir la liste des dessus de table compatibles aux pages 223, 225, 228 et 229*

# Parade

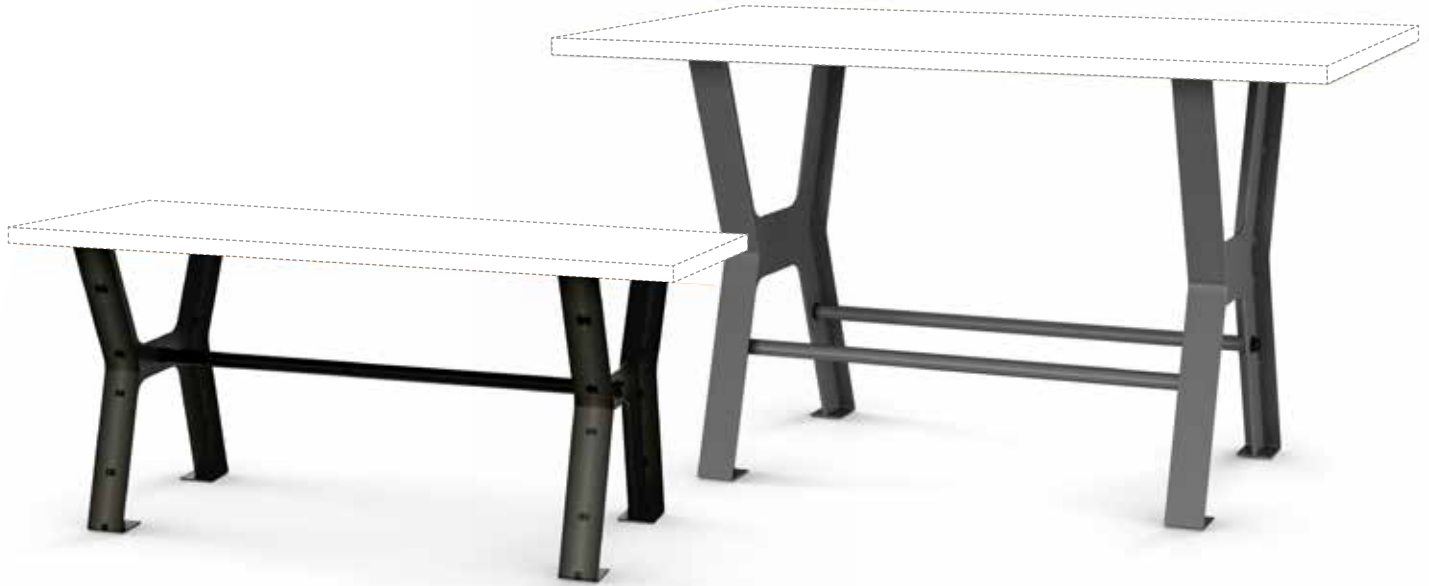

50566-CO

**TABLE BASE  
(SHORT VERSION)**

Top not included

Metal color shown/ Couleur de métal montrée : Harley (51)

**BASE DE TABLE  
(VERSION COURTE)**

Dessus de table non inclus

50566-36CO

**TABLE BASE  
(COUNTER HEIGHT-  
SHORT VERSION)**

Top not included

**BASE DE TABLE  
(HAUTEUR COMPTOIR-  
VERSION COURTE)**

Dessus de table non inclus

50566-42CO

**TABLE BASE  
(BAR HEIGHT-  
SHORT VERSION)**

Top not included

**BASE DE TABLE  
(HAUTEUR BAR-  
VERSION COURTE)**

Dessus de table non inclus

Metal color shown/ Couleur de métal montrée : Metallo (57)

Table height/ Hauteur table

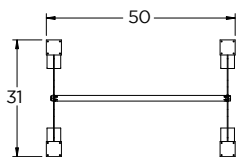

Top view/ Vue de dessus

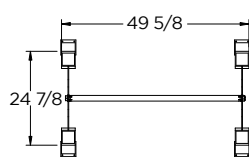

Bottom view/ Vue de dessous

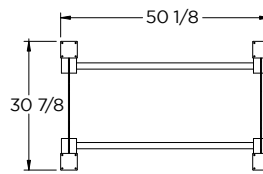

Top view/ Vue de dessus

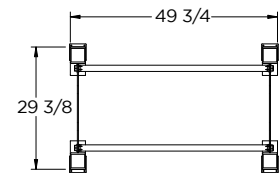

Bottom view/ Vue de dessous

Counter and bar height/ Hauteur comptoir et bar

**STEEL TABLE BASE MEASUREMENTS (WITHOUT TOP)  
MESURES DE BASE DE TABLE EN MÉTAL (SANS DESSUS DE TABLE)**

	W/L in/po	D/P in/po	H in/po	W/P lb
<b>50566-CO</b>	31	50	29 1/4	50
<b>50566-36CO</b>	30 7/8	49 3/4	35 1/4	56
<b>50566-42CO</b>	30 7/8	49 3/4	41 1/4	66

See the list of compatible tabletops on pages 223, 225, 228 and 229 / Voir la liste des dessus de table compatibles aux pages 223, 225, 228 et 229

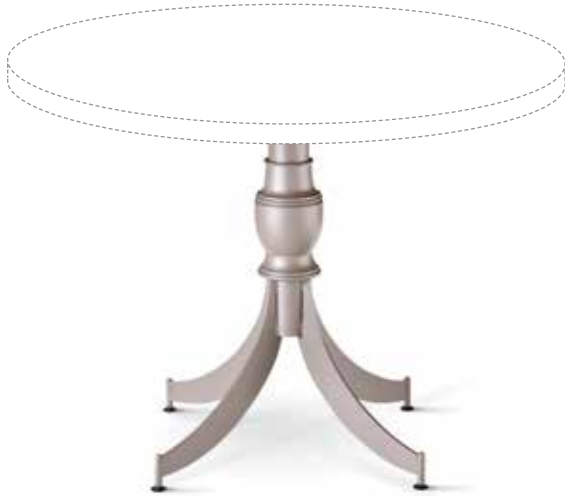

50601-CO

**TABLE BASE**

Includes adjustable glides  
Top not included

**BASE DE TABLE**

Avec glisseurs ajustables  
Dessus de table non inclus

Metal color shown / Couleur de métal montrée : Titanium (56)

Not available in Magnetite (24) metal color  
Non disponible dans la couleur de métal Magnetite (24)



50701-CO

**TABLE BASE  
(COUNTER HEIGHT)**

Includes adjustable glides  
Top not included

**BASE DE TABLE  
(HAUTEUR COMPTOIR)**

Avec glisseurs ajustables  
Dessus de table non inclus

50801-CO

**TABLE BASE  
(BAR HEIGHT)**

Includes adjustable glides  
Top not included

**BASE DE TABLE  
(HAUTEUR BAR)**

Avec glisseurs ajustables  
Dessus de table non inclus

Metal color shown / Couleur de métal montrée : Titanium (56)

Not available in Magnetite (24) metal color  
Non disponible dans la couleur de métal Magnetite (24)

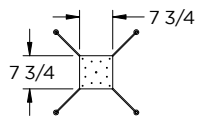

Top view / Vue de dessus

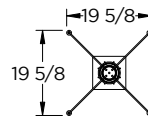

Bottom view / Vue de dessous

**STEEL TABLE BASE MEASUREMENTS (WITHOUT TOP)**  
**MESURES DE BASE DE TABLE EN MÉTAL (SANS DESSUS DE TABLE)**

	W/L in/po	D/P in/po	H in/po	W/P lb
<b>50601-CO</b>	19 5/8	19 5/8	28 5/8	22
<b>50701-CO</b>	19 5/8	19 5/8	34 5/8	24
<b>50801-CO</b>	19 5/8	19 5/8	40 5/8	26

See the list of compatible tabletops on pages 223 225, 228 and 229 / Voir la liste des dessus de table compatibles aux pages 223, 225, 228 et 229



50664-CO

**TABLE BASE**

Top not included

Metal color shown/ Couleur de métal montrée : Magnetite (24)

**BASE DE TABLE**

Dessus de table non inclus

50664-36CO

**TABLE BASE  
(COUNTER HEIGHT)**

Top not included

**BASE DE TABLE  
(HAUTEUR COMPTOIR)**

Dessus de table non inclus

50664-42CO

**TABLE BASE  
(BAR HEIGHT)**

Top not included

**BASE DE TABLE  
(HAUTEUR BAR)**

Dessus de table non inclus

Metal color shown/ Couleur de métal montrée : Magnetite (24)

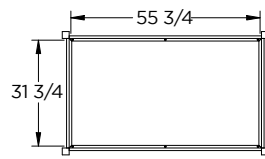

Top view/ Vue de dessus

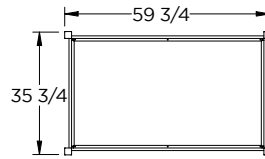

Bottom view/ Vue de dessous

**STEEL TABLE BASE MEASUREMENTS (WITHOUT TOP)**  
**MESURES DE BASE DE TABLE EN MÉTAL (SANS DESSUS DE TABLE)**

	W/L in/ po	D/P in/ po	H in/ po	W/P lb
<b>50664-CO</b>	35 3/4	59 3/4	28 7/8	36.5
<b>50664-36CO</b>	35 3/4	59 3/4	34 7/8	38.5
<b>50664-42CO</b>	35 3/4	59 3/4	40 7/8	42.5

See the list of compatible tabletops on pages 223 225, 228 and 229 / Voir la liste des dessus de table compatibles aux pages 223, 225, 228 et 229



50698-CO

**TABLE BASE**

Top not included

Metal color shown / *Couleur de métal montrée* : Magnetite (24)

Not available in Snow (63) metal color  
*Non disponible dans la couleur de métal Snow (63)*

**BASE DE TABLE**

*Dessus de table non inclus*

50798-CO

**TABLE BASE  
(COUNTER HEIGHT)**

Top not included

Metal color shown / *Couleur de métal montrée* : Magnetite (24)

50898-CO

**TABLE BASE  
(BAR HEIGHT)**

Top not included

Metal color shown / *Couleur de métal montrée* : Magnetite (24)

Not available in Snow (63) metal color  
*Non disponible dans la couleur de métal Snow (63)*

**BASE DE TABLE  
(HAUTEUR COMPTOIR)**

*Dessus de table non inclus*

**BASE DE TABLE  
(HAUTEUR BAR)**

*Dessus de table non inclus*

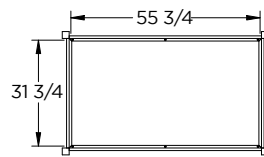

Top view / *Vue de dessus*

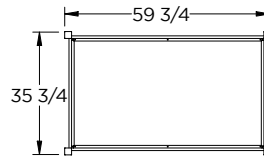

Bottom view / *Vue de dessous*

**STEEL TABLE BASE MEASUREMENTS (WITHOUT TOP)**  
**MESURES DE BASE DE TABLE EN MÉTAL (SANS DESSUS DE TABLE)**

	W/L in/po	D/P in/po	H in/po	W/P lb
<b>50698-CO</b>	35 3/4	59 3/4	29 5/8	36.5
<b>50798-CO</b>	35 3/4	59 3/4	35 5/8	47.5
<b>50898-CO</b>	35 3/4	59 3/4	41 5/8	51.5

See the list of compatible tabletops on pages 223 225, 228 and 229 / *Voir la liste des dessus de table compatibles aux pages 223, 225, 228 et 229*



# Salton



50500-CO

**TABLE BASE**

Includes adjustable glides  
Top not included

**BASE DE TABLE**

Avec glisseurs ajustables  
Dessus de table non inclus

Metal color shown / Couleur de métal montrée : Oxidado (52)

Not available in Magnetite (24) metal color / Non disponible dans la couleur métal Magnetite (24)



50500-36CO

**TABLE BASE  
(COUNTER HEIGHT)**

Includes adjustable glides  
Top not included

**BASE DE TABLE  
(HAUTEUR COMPTOIR)**

Avec glisseurs ajustables  
Dessus de table non inclus

Not available in Magnetite (24) metal color / Non disponible dans la couleur métal Magnetite (24)

50500-42CO

**TABLE BASE  
(BAR HEIGHT)**

Includes adjustable glides  
Top not included

**BASE DE TABLE  
(HAUTEUR BAR)**

Avec glisseurs ajustables  
Dessus de table non inclus

Metal color shown / Couleur de métal montrée : Oxidado (52)

Not available in Magnetite (24) metal color / Non disponible dans la couleur métal Magnetite (24)

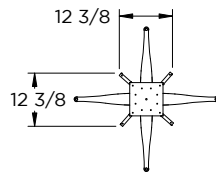

Top view / Vue de dessus

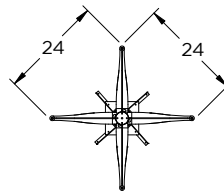

Bottom view / Vue de dessous

**STEEL TABLE BASE MEASUREMENTS (WITHOUT TOP)  
MESURES DE BASE DE TABLE EN MÉTAL (SANS DESSUS DE TABLE)**

	W/L in/po	D/P in/po	H in/po	W/P lb
<b>50500-CO</b>	24	24	28 7/8	24.5
<b>50500-36CO</b>	24	24	34 7/8	25.5
<b>50500-42CO</b>	24	24	40 7/8	26.5

See the list of compatible tabletops on pages 223 225, 228 and 229 / Voir la liste des dessus de table compatibles aux pages 223, 225, 228 et 229



52554-CO

**TABLE BASE  
(LONG VERSION)**

Top not included

Metal color shown/ Couleur de métal montrée : Harley (51)

**BASE DE TABLE  
(VERSION LONGUE)**

Dessus de table non inclus

52556-CO

**TABLE BASE  
(SHORT VERSION)**

Top not included

Metal color shown/ Couleur de métal montrée : Harley (51)

**BASE DE TABLE  
(VERSION COURTE)**

Dessus de table non inclus

Long version/ Version longue

Short version/ Version courte

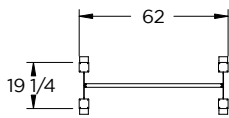

Top view/ Vue de dessus

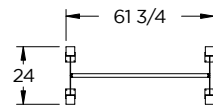

Bottom view/ Vue de dessous

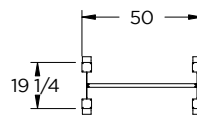

Top view/ Vue de dessus

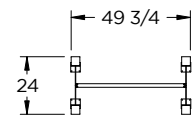

Bottom view/ Vue de dessous

**STEEL TABLE BASE MEASUREMENTS (WITHOUT TOP)  
MESURES DE BASE DE TABLE EN MÉTAL (SANS DESSUS DE TABLE)**

	W/L in/ po	D/P in/ po	H in/ po	W/P lb
<b>52554-CO</b>	24	62	29 1/4	49
<b>52556-CO</b>	24	50	29 1/4	48

See the list of compatible tabletops on pages 223, 225, 228 and 229 / Voir la liste des dessus de table compatibles aux pages 223, 225, 228 et 229

# Southcross



50562-CO

**TABLE BASE  
(SHORT VERSION)**

Includes adjustable glides  
Top not included

Metal color shown / Couleur de métal montrée : Harley (51)

**BASE DE TABLE  
(VERSION COURTE)**

Avec glisseurs ajustables  
Dessus de table non inclus

50567-CO

**TABLE BASE  
(LONG VERSION)**

Includes adjustable glides  
Top not included

Metal color shown / Couleur de métal montrée : Harley (51)

**BASE DE TABLE  
(VERSION LONGUE)**

Avec glisseurs ajustables  
Dessus de table non inclus

Short version / Version courte

Long version / Version longue

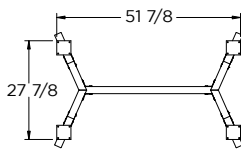

Top view / Vue de dessus

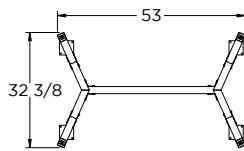

Bottom view / Vue de dessous

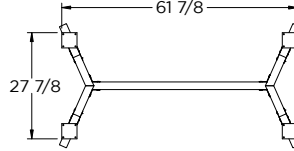

Top view / Vue de dessus

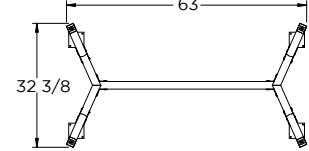

Bottom view / Vue de dessous

**STEEL TABLE BASE MEASUREMENTS (WITHOUT TOP)  
MESURES DE BASE DE TABLE EN MÉTAL (SANS DESSUS DE TABLE)**

	W/L in/po	D/P in/po	H in/po	W/P lb
50562-CO	32 3/8	53	29 1/8	24
50567-CO	32 3/8	63	29 1/8	25

See the list of compatible tabletops on pages 223 225, 228 and 229 / Voir la liste des dessus de table compatibles aux pages 223, 225, 228 et 229

## Self-Leveling Spring Loaded Glides *Glisseurs auto nivelants à ressort*



### FEATURES

- Fit uneven floors and prevent floor damage
- Stabilize tables by pressing on the tabletop
- Inner lock improves table stability
- Allow table alignment when two identical tables are joined
- Highly durable
- Easy to install, no tools required
- Increase the height of your table from 1/4" to 1/2"

### HOW TO INSTALL

1. Remove the original glides
2. Screw the self-leveling spring loaded glides

### HOW TO USE THEM

1. Apply a pressure on one of the legs around which the table wobbles
2. To return the glides to their original position, lift the table

### HOW TO ORDER THEM

- Use the SKU M406212501
- Indicate the desired quantity (4 per table)

### CARACTÉRISTIQUES

- S'adaptent aux planchers inégaux et préviennent les bris de plancher
- Stabilisent la table avec une simple pression sur le dessus de table
- Des verrous internes améliorent la stabilité de la table
- Permettent l'alignement des tables lorsque deux tables identiques sont juxtaposées
- Très durables
- S'installent facilement, sans l'aide d'outils
- Augmentent la hauteur de votre table de 1/4" à 1/2"

### COMMENT LES INSTALLER

1. Retirer les glisseurs d'origine
2. Visser les glisseurs auto nivelants à ressort

### COMMENT LES UTILISER

1. Appuyer sur l'une des pattes autour desquelles la table se balance
2. Pour remettre le glisseur à sa position d'origine, soulever la table

### COMMENT COMMANDER

- Utiliser le numéro de produit M406212501
- Indiquer la quantité désirée (4 par table)

### COMPATIBLE WITH THESE TABLE BASES *COMPATIBLES AVEC CES BASES DE TABLE*

**Billy** 50551/-36/-42  
**Dirk** 50634/734/834  
**Judy** 50550/-36/-42

**Laredo** 52553  
**Moris** 50571/581  
**Norcross** 50563/-36/-42

**Penelope** 50601/701/801  
**Salton** 50500/-36/-42  
**Southcross** 50562/567

# Regular Tabletop Program

## Programme de dessus de table réguliers

### Distressed Solid Wood Tabletops (birch)

#### Dessus de table en bois massif usé (merisier)

#### FEATURES

- Responsibly harvested North American wood
- Distressed solid birch
- Available in 6 colors
- 5% sheen catalysed lacquer
- Flat edge
- No distressed solid wood tabletops minimum quantity required when the order qualifies

#### CARACTÉRISTIQUES

- Bois de provenance nord-américaine récolté de façon responsable
- Merisier massif usé
- Disponible en 6 couleurs
- Laque catalysée avec une brillance de 5%
- Chants droits
- Pas de quantité minimale de dessus de table en bois massif usé requise lorsque la commande se qualifie

#### SIZES AVAILABLE / DIMENSIONS DISPONIBLES



**90403-CO**  
30" dia. x 1 1/16"



**90406-CO**  
36" dia. x 1 1/16"



**90412-CO**  
42" dia. x 1 1/16"



**90409-CO**  
52" dia. x 1 1/2"



**90407-CO**  
52" dia. x 1 1/2"  
with decorative bolts / avec vis décoratives



**90408-CO**  
36" x 36" x 1 1/16"  
without decorative bolts / sans vis décoratives



**90851-CO**  
28" x 48" x 1 1/16"



**90410-CO**  
36" x 60" x 1 1/16"



**90486-CO**  
40" x 72" x 1 1/2"  
with decorative bolts / avec vis décoratives



**90487-CO**  
40" x 72" x 1 1/2"  
without decorative bolts / sans vis décoratives



**90484-CO**  
40" x 84" x 1 1/2"  
with decorative bolts / avec vis décoratives



**90485-CO**  
40" x 84" x 1 1/2"  
without decorative bolts / sans vis décoratives

#### COLORS AVAILABLE / COULEURS DISPONIBLES



Distressed solid wood tabletops are available in special sizes. Please refer to the "Custom Tabletop Program" section on page 226 for more details. Les dessus de table en bois massif usé sont disponibles en formats spéciaux. Veuillez vous référer à la section «Programme de dessus de table sur mesure» à la page 226 pour plus de détails.

## Table Base and Distressed Solid Wood Tabletop (birch) Combinations Combinaisons de bases et de dessus de table en bois massif usé (merisier)

			30" dia. 90403-CO	36" dia. 90406-CO	42" dia. 90412-CO	52" dia. 90407-CO/409-CO	36" x 36" 90408-CO	28" x 48" 90851-CO	36" x 60" 90410-CO	40" x 72" 90486-CO/487-CO	40" x 84" 90484-CO/485-CO	
DINING HEIGHT TABLE BASES BASES DE TABLE HAUTEUR DINETTE	50570-CO Alys (S.T.)	Δ		•	•		•					
	50580-CO Alys (R.T.)	Δ							•			
	50660-CO Bennington									•		
	50551-CO Billy	Δ	•	•	•		•	•	2			
	50557-CO Burton						•		•	•	•	
	50696-CO Cameron						•					
	50662-CO Carbon						•					
	50507-CO Dalia		•	•	•		•					
	50547-CO Dalia XL				•							
	50634-CO Dirk			•	•		•	•				
	50071-PACO Eliot				•		•	•	•			
	50536-CO Genesis				•	•	•					
	50668-CO Harrison							•				
	50550-CO Judy	Δ	•	•	•		•	•	2			
	50609-CO Kai			•	•		•					
	52553-CO Laredo	Δ									•	
	50583-PACO Lidya								•	•	•	
	50552-CO Link (S.V.)										•	
	50553-CO Link (L.V.)											•
	50538-CO Martina						•					
	50571-CO Moris (S.T.)	Δ			•	•		•				
	50581-CO Moris (R.T.)	Δ								•		
	50667-CO Nicholson											•
	50563-CO Norcross	Δ		•	•			•		2		
	50565-CO Parade (L.V.)											•
	50566-CO Parade (S.V.)										•	
	50601-CO Penelope	Δ	•	•	•		•	•	2			
	50664-CO Ricard									•		
	50698-CO Robert									•		
	50500-CO Salton	Δ		•	•	•	•	•	2	2	2	
	52554-CO Sierra (L.V.)											•
	52556-CO Sierra (S.V.)										•	
	50562-CO Southcross (S.V.)	Δ								•	•	
	50567-CO Southcross (L.V.)	Δ										•
50660-36/42CO Bennington										•		
50551-36/42CO Billy	Δ	•	•	•		•	•	2				
50796/896CO Cameron						•						
50662-36/42CO Carbon						•						
50507-38/42CO Dalia		•	•	•		•						
50734/834CO Dirk	Δ		•	•		•	•					
50536-36/42CO Genesis				•	•	•						
50668-36/42CO Harrison							•					
50550-36/42CO Judy	Δ	•	•	•		•	•	2				
50709/809CO Kai			•	•		•						
50554-36/42CO Link	Δ	•	•	•		•						
50667-36/42CO Nicholson											•	
50563-36/42CO Norcross	Δ		•	•		•		2				
50565-36/42CO Parade (L.V.)											•	
50566-36/42CO Parade (S.V.)										•		
50701/801CO Penelope	Δ	•	•	•		•	•	2				
50664-36/42CO Ricard									•			
50798/898CO Robert									•			
50500-36/42CO Salton	Δ		•	•		•	•	2	2	2		

2 = The tabletop requires 2 bases / Ce dessus de table exige 2 bases de table  
 Δ = Adjustable glides / Glisseurs ajustables  
 S.T. = Square table base / Base de table carrée

R.T. = Rectangular table base / Base de table rectangulaire  
 S.V. = Short version / Version courte  
 L.V. = Long version / Version longue



## Solid Wood Tabletops (ash) *Dessus de table en bois massif (frêne)*

### FEATURES

- Responsibly harvested North American wood
- Available in 8 colors
- 5% sheen catalysed lacquer
- No solid wood tabletops minimum quantity required when the order qualifies

### CARACTÉRISTIQUES

- Bois de provenance nord-américaine récolté de façon responsable
- Disponible en 8 couleurs
- Laque catalysée avec une brillance de 5%
- Pas de quantité minimale de dessus de table en bois massif requise lorsque la commande se qualifie

### SIZES AVAILABLE / DIMENSIONS DISPONIBLES

Beveled Edge / *Chant en biseau*



**93406-CO**  
36" dia. x 1 1/16"



**93412-CO**  
42" dia. x 1 1/16"



**93438-CO**  
38" x 38" x 1 1/16"

Flat Edge / *Chant droit*



**93408-CO**  
36" x 36" x 1 1/16"



**93428-CO**  
28" x 48" x 1 1/16"



**93410-CO**  
36" x 60" x 1 1/16"



**93487-CO**  
40" x 72" x 1 1/2"











**93485-CO**  
40" x 84" x 1 1/2"

### COLORS AVAILABLE / COULEURS DISPONIBLES



Solid wood (ash) tabletops are available in special sizes. Please refer to the "Custom Tabletop Program" section on page 226 for more details.  
*Les dessus de table en bois massif (frêne) sont disponibles en formats spéciaux. Veuillez vous référer à la section «Programme de dessus de table sur mesure» à la page 226 pour plus de détails.*

## Table Base and Solid Wood Tabletop (ash) Combinations Combinaisons de bases et de dessus de table en bois massif (frêne)

			 36" dia. 93406-CO*	 42" dia. 93412-CO*	 36" x 36" 93408-CO	 38" x 38" 93438-CO*	 28" x 48" 93428-CO	 36" x 60" 93410-CO	 40" x 72" 93487-CO	 40" x 84" 93485-CO
DINING HEIGHT TABLE BASES BASES DE TABLE HAUTEUR DINETTE	50570-CO Alys (S.T.)	Δ		•	•					
	50580-CO Alys (R.T.)	Δ						•		
	50660-CO Bennington								•	
	50551-CO Billy	Δ	•	•	•	•	•	2		
	50557-CO Burton				•	•		•	•	•
	50696-CO Cameron				•					
	50662-CO Carbon				•					
	50507-CO Dalia			•	•	•	•			
	50547-CO Dalia XL				•					
	50634-CO Dirk			•	•	•	•	•		
	50071-PACO Eliot			•	•	•	•	•		
	50536-CO Genesis			•	•	•	•			
	50668-CO Harrison							•		
	50550-CO Judy	Δ	•	•	•	•	•	2		
	50609-CO Kai			•	•	•				
	52553-CO Laredo	Δ								
	50583-PACO Lidya							•	•	•
	50552-CO Link (S.V.)								•	
	50553-CO Link (L.V.)									•
	50571-CO Moris (S.T.)	Δ			•	•				
	50581-CO Moris (R.T.)	Δ							•	
	50667-CO Nicholson									•
	50563-CO Norcross	Δ	•	•	•			2		
	50565-CO Parade (L.V.)									•
	50566-CO Parade (S.V.)								•	
	50601-CO Penelope	Δ	•	•	•	•	•	2		
	50664-CO Ricard							•		
	50698-CO Robert							•		
	50500-CO Salton	Δ	•	•	•	•	•	2	2	2
	52554-CO Sierra (L.V.)									•
	52556-CO Sierra (S.V.)								•	
	50562-CO Southcross (S.V.)	Δ						•	•	
50567-CO Southcross (L.V.)	Δ								•	
COUNTER & BAR HEIGHT TABLE BASES BASES DE TABLE HAUTEUR COMPTOIR ET BAR	50660-36/42CO Bennington								•	
	50551-36/42CO Billy	Δ	•	•	•	•	•	2		
	50796/896CO Cameron				•					
	50662-36/42CO Carbon				•					
	50507-38/42CO Dalia		•	•	•	•				
	50734/834CO Dirk	Δ	•	•	•	•	•			
	50536-36/42CO Genesis		•	•	•	•				
	50668-36/42CO Harrison							•		
	50550-36/42CO Judy	Δ	•	•	•	•	•	2		
	50709/809CO Kai		•	•	•	•				
	50554-36/42CO Link	Δ	•	•	•	•				
	50667-36/42CO Nicholson									•
	50563-36/42CO Norcross	Δ	•	•	•		•	2		
	50565-36/42CO Parade (L.V.)									•
	50566-36/42CO Parade (S.V.)								•	
	50701/801CO Penelope	Δ	•	•	•	•	•	2		
	50664-36/42CO Ricard							•		
	50798/898CO Robert							•		
50500-36/42CO Salton	Δ	•	•	•	•	•	2	2	2	

2 = The tabletop requires 2 bases / Ce dessus de table exige 2 bases de table

Δ = Adjustable glides / Glisseurs ajustables

\* Beveled edge / Chant en biseau

S.T. = Square table base / Base de table carrée

R.T. = Rectangular table base / Base de table rectangulaire

S.V. = Short version / Version courte

L.V. = Long version / Version longue

# Custom Tabletop Program

## Programme de dessus de table sur mesure

Custom tabletops minimum order is 5 identical tabletops (same size, same color, same finish). Occasionally, orders with less than 5 identical tabletops can be accepted, but extra charges will apply. Please contact Amisco for pricing.

*La quantité minimale de dessus de table sur mesure est de 5 dessus de table identiques (mêmes dimensions, même couleur, même fini). À l'occasion, des commandes contenant moins de 5 dessus de table identiques peuvent être acceptées, mais des frais additionnels s'appliqueront. Veuillez contacter Amisco pour une soumission.*

### Distressed Solid Wood Tabletops (birch) Dessus de table en bois massif usé (merisier)

#### FEATURES

- Responsibly harvested North American wood
- Distressed solid birch
- Available in 6 colors
- 5% sheen catalysed lacquer
- 1 1/16" Thick
- Flat edge only
- Decorative bolts not available on edges

#### CARACTÉRISTIQUES

- Bois de provenance nord-américaine récolté de façon responsable
- Merisier massif usé
- Disponibles en 6 couleurs
- Laque catalysée avec une brillance de 5%
- Épaisseur de 1 1/16"
- Chants droits
- Vis décoratives non disponibles sur les chants

#### COLORS AVAILABLE / COULEURS DISPONIBLES



### Solid Wood Tabletops (ash) / Dessus de table en bois massif (frêne)

#### FEATURES

- Responsibly harvested North American wood
- Available in 8 colors
- 5% sheen catalysed lacquer
- 1 1/16" Thick
- Flat edge only

#### CARACTÉRISTIQUES

- Bois de provenance nord-américaine récolté de façon responsable
- Disponible en 8 couleurs
- Laque catalysée avec une brillance de 5%
- Épaisseur de 1 1/16"
- Chants droits seulement

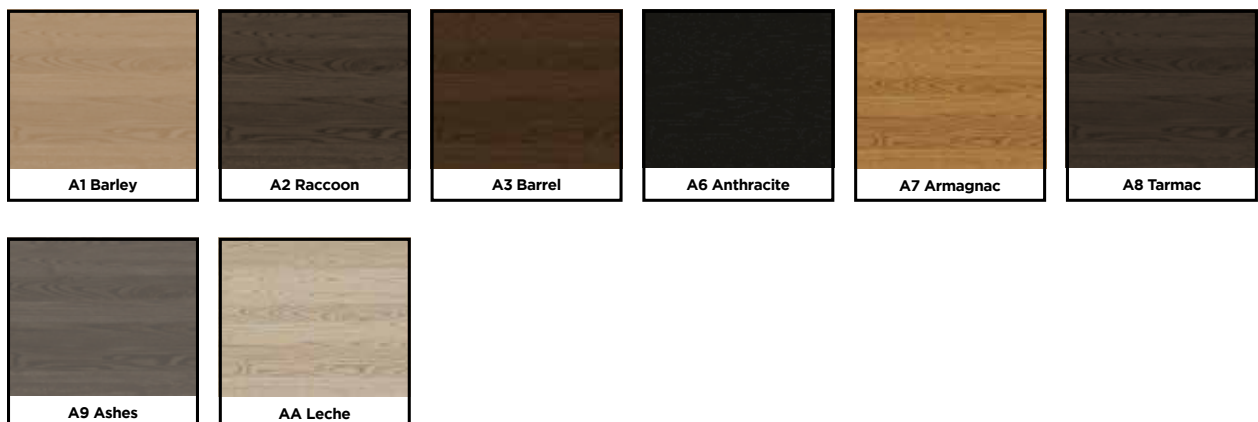

## Laminate Tabletops

Our laminate tabletop offer includes standard patterns of Formica, Wilsonart, Arborite, Nevamar and Pionite. Specialty laminates, Laminart and gloss finishes are also available. All tabletops more than 60" wide will have a splice in the laminate face.

## Dessus de table en stratifié

Notre offre de dessus de table en stratifié comprend les modèles standards de Formica, Wilsonart, Arborite, Nevamar et Pionite. Vous pouvez également commander des stratifiés spécialisés, du Laminart et des finis brillants. Notez que les dessus de table de plus de 60" de large auront une coupure sur la surface du stratifié.

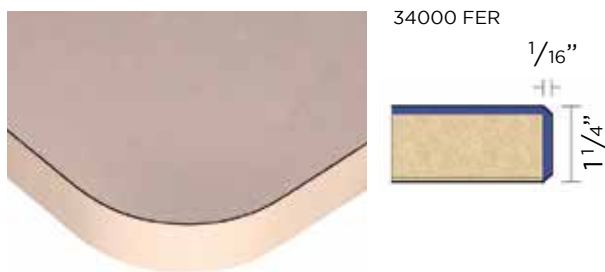
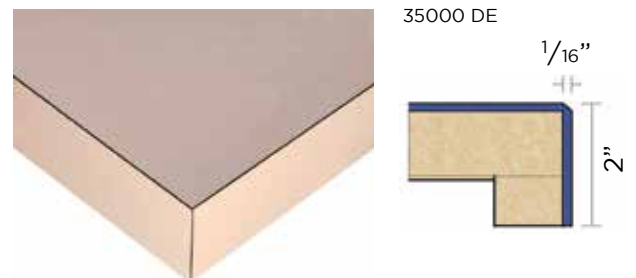
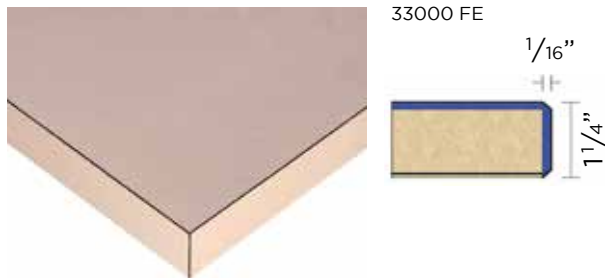
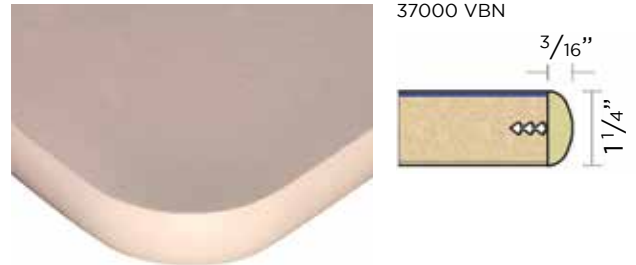
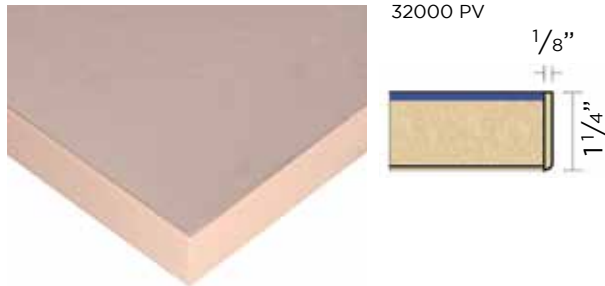

## Table Base and Tabletop Combinations

This chart is subject to change over time. Please refer to our website to find the most up-to-date chart.

## Combinaisons de bases et dessus de table

Cette charte est sujet au changement. S.V.P. Référez-vous à notre site Internet pour trouver la charte la plus à jour.

		COMMON TABLETOP SIZES / DIMENSIONS DE DESSUS DE TABLE STANDARD																		
		24" x 24"	24" x 30"	24" x 36"	24" x 42"	24" x 48"	24" x 60"	24" x 72"	24" x 84"	24" x 96"	28" x 48"	30" x 30"	30" x 36"	30" x 42"	30" x 48"	30" x 60"	30" x 72"	30" x 84"	30" x 96"	
DINING HEIGHT TABLE BASES BASES DE TABLE HAUTEUR DINETTE	50570-CO Alys (S.T.)	Δ																		
	50580-CO Alys (R.T.)	Δ																		
	50660-CO Bennigton																			
	50551-CO Billy	Δ	•	•	•	•	•	•	•	•	•	•	•	•	•	•	•	•	•	•
	50557-CO Burton																			
	50696-CO Cameron																			
	50662-CO Carbon																			
	50507-CO Dalia																			
	50547-CO Dalia XL																			
	50634-CO Dirk																			
	50071-PACO Eliot																			
	50536-CO Genesis																			
	50668-CO Harrison																			
	50550-CO Judy	Δ	•	•	•	•	•	•	•	•	•	•	•	•	•	•	•	•	•	•
	50609-CO Kai																			
	52553-CO Laredo	Δ																		
	50583-PACO Lidya																			
	50552-CO Link (S.V.)																			
	50553-CO Link (L.V.)																			
	50538-CO Martina																			
	50571-CO Moris (S.T.)	Δ																		
	50581-CO Moris (R.T.)	Δ																		
	50667-CO Nicholson																			
	50563-CO Norcross	Δ																		
	50565-CO Parade (L.V.)																			
	50566-CO Parade (S.V.)																			
	50601-CO Penelope	Δ	•	•	•	•	•	•	•	•	•	•	•	•	•	•	•	•	•	•
	50664-CO Ricard																			
	50698-CO Robert																			
	50500-CO Salton	Δ	•	•	•	•	•	•	•	•	•	•	•	•	•	•	•	•	•	•
52554-CO Sierra (L.V.)	Δ																			
52556-CO Sierra (S.V.)																				
50562-CO Southcross (S.V.)	Δ																			
50567-CO Southcross (L.V.)	Δ																			
COUNTER & BAR HEIGHT TABLE BASES BASES DE TABLE HAUTEUR COMPTOIR ET BAR	50660-36/42CO Bennigton																			
	50551-36/42CO Billy	Δ	•	•	•	•	•	•	•	•	•	•	•	•	•	•	•	•	•	
	50796/896CO Cameron																			
	50662-36/42CO Carbon																			
	50507-38/42CO Dalia																			
	50734/834CO Dirk	Δ	•	•	•	•	•	•	•	•	•	•	•	•	•	•	•	•	•	
	50536-36/42CO Genesis																			
	50668-36/42CO Harrison																			
	50550-36/42CO Judy	Δ	•	•	•	•	•	•	•	•	•	•	•	•	•	•	•	•	•	
	50709/809CO Kai																			
	50554-36/42CO Link																			
	50667-36/42CO Nicholson																			
	50563-36/42CO Norcross	Δ	•	•	•	•	•	•	•	•	•	•	•	•	•	•	•	•	•	
	50565-36/42CO Parade (L.V.)																			
	50566-36/42CO Parade (S.V.)																			
	50701/801CO Penelope	Δ	•	•	•	•	•	•	•	•	•	•	•	•	•	•	•	•	•	
50664-36/42CO Ricard																				
50798/898CO Robert																				
50500-36/42CO Salton	Δ	•	•	•	•	•	•	•	•	•	•	•	•	•	•	•	•	•		

• = Possible fit (tabletop weight can make difference)  
*Combinaison possible (le poids du dessus de table peut faire une différence)*

2 = The tabletop requires 2 bases / *Ce dessus de table exige 2 bases de table*

Δ = Adjustable glides / *Glisseurs ajustables*

S.T. = Square table base / *Base de table carrée*

R.T. = Rectangular table base / *Base de table rectangulaire*

S.V. = Short version / *Versión courte*

L.V. = Long version / *Versión longue*

## Table Base and Tabletop Combinations

This chart is subject to change over time. Please refer to our website to find the most up-to-date chart.

## Combinaisons de bases et dessus de table

Cette charte est sujet au changement. S.V.P. Référez-vous à notre site Internet pour trouver la charte la plus à jour.

		COMMON TABLETOP SIZES / DIMENSIONS DE DESSUS DE TABLE STANDARD																		
		36" x 36"	36" x 42"	36" x 48"	36" x 60"	36" x 72"	36" x 84"	36" x 96"	40" x 40"	40" x 48"	40" x 60"	40" x 72"	40" x 84"	40" x 96"	48" x 96"	30" dia.	36" dia.	42" dia.	48" dia.	54" dia.
DINING HEIGHT TABLE BASES BASES DE TABLE HAUTEUR DINETTE	50570-CO Alys (S.T.)	Δ	•	•					•								•	•	•	•
	50580-CO Alys (R.T.)	Δ			•	•														
	50660-CO Bennigton											•								
	50551-CO Billy	Δ	•	•	2	2	2	2	•	2	2	2	2	2	2	•	•	•		
	50557-CO Burton		•	•	•	•	•	•	•	•	•	•	•							
	50696-CO Cameron		•																	
	50662-CO Carbon		•																	
	50507-CO Dalia		•														•	•	•	
	50547-CO Dalia XL																		•	•
	50634-CO Dirk		•	•	•			2	2	•	•		2	2	2			•	•	•
	50071-PACO Eliot		•	•	•	•				•	•	•						•	•	•
	50536-CO Genesis		•	•	•			2	2	•	•		2	2	2			•	•	•
	50668-CO Harrison																			
	50550-CO Judy	Δ	•	•	2	2	2	2	2	•	2	2	2	2	2	2	•	•	•	
	50609-CO Kai		•	•	•					•	•							•	•	
	52553-CO Laredo					•	•					•	•							
	50583-PACO Lidya					•	•	•				•	•	•						
	50552-CO Link (S.V.)					•						•								
	50553-CO Link (L.V.)							•					•							
	50538-CO Martina		•	•	•					•	•							•	•	•
	50571-CO Moris (S.T.)	Δ	•	•														•	•	•
	50581-CO Moris (R.T.)	Δ				•	•					•	•							
	50667-CO Nicholson													•						
	50563-CO Norcross	Δ	•	•		2	2	2	2	•		2	2	2	2			•	•	•
	50565-CO Parade (L.V.)								•	•				•	•	•				
	50566-CO Parade (S.V.)							•				•								
	50601-CO Penelope	Δ	•	•	2	2	2	2		•	2	2	2	2			•	•	•	
	50664-CO Ricard					•														
50698-CO Robert					•															
50500-CO Salton	Δ	•	•	•	2	2	2	2	•	•	2	2	2	2	2	•	•	•	•	
52554-CO Sierra (L.V.)	Δ							•	•			•	•	•						
52556-CO Sierra (S.V.)					•						•									
50562-CO Southcross (S.V.)	Δ				•	•					•	•								
50567-CO Southcross (L.V.)	Δ						•					•								
COUNTER & BAR HEIGHT TABLE BASES BASES DE TABLE HAUTEUR COMPTOIR ET BAR	50660-36/42CO Bennigton												•							
	50551-36/42CO Billy	Δ	•	•	2	2	2	2	•	2	2	2	2	2	2	•	•	•		
	50796/896CO Cameron		•																	
	50662-36/42CO Carbon		•																	
	50507-38/42CO Dalia		•														•	•	•	
	50734/834CO Dirk	Δ	•	•	•			2	2	•	•			2	2	2		•	•	
	50536-36/42CO Genesis		•	•	•			2	2	•	•			2	2	2		•	•	
	50668-36/42CO Harrison																			
	50550-36/42CO Judy	Δ	•	•	2	2	2	2	2	•	2	2	2	2	2	2	•	•	•	
	50709/809CO Kai		•	•	•					•	•							•	•	
	50554-36/42CO Link		•	•						•								•	•	
	50667-36/42CO Nicholson																			
	50563-36/42CO Norcross	Δ	•	•		2	2	2		•		2	2	2				•	•	
	50565-36/42CO Parade (L.V.)													•						
	50566-36/42CO Parade (S.V.)												•							
	50701/801CO Penelope	Δ	•	•	2	2	2	2		•	2	2	2	2			•	•	•	
50664-36/42CO Ricard					•															
50798/898CO Robert					•															
50500-36/42CO Salton	Δ	•	•	•	2	2	2		•	•	2	2	2	2	2		•	•	•	

- = Possible fit (tabletop weight can make difference)  
Combinaison possible (le poids du dessus de table peut faire une différence)  
2 = The tabletop requires 2 bases / Ce dessus de table exige 2 bases de table  
Δ = Adjustable glides / Glisseurs ajustables

- S.T. = Square table base / Base de table carrée  
R.T. = Rectangular table base / Base de table rectangulaire  
S.V. = Short version / Version courte  
L.V. = Long version / Version longue





**Legend** 13501-PMCO

Wall mounted upholstered headboard  
*Tête de lit murale rembourrée*

## Wall Mounted Upholstered Headboards *Têtes de lit murales rembourrées*

### FEATURES

- 11 headboard designs
- Sturdy, durable construction
- Solid wall fixation with a built-in French cleat
- Easy installation
- Available in Twin, Full, Queen and King sizes

### CARACTÉRISTIQUES

- 11 designs de têtes de lit
- Construction solide et durable
- Fixation murale en clef française
- Installation facile
- Disponible en 39", 54", 60" et 78"

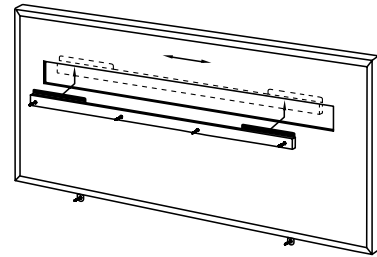

**13501-PMCO** LEGEND

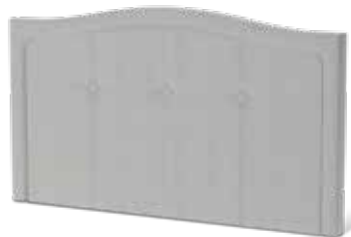

**13503-PMCO** CROCUS



**13504-PMCO** BREEZE



**13504-PMCO** BREEZE



**13507-PMCO** ELEGANCE



**13508-PMCO** NAMASTE



**13509-PMCO** MURO



**13510-PMCO** GRANVILLE



**13511-PMCO** GASTOWN



**13518-PMCO** NANAIMO



**13523-PMCO** BOUNTY

# Bounty



13523-PMCO

**WALL MOUNTED  
UPHOLSTERED  
HEADBOARD**

With distressed solid wood  
insert (birch)

**TÊTE DE LIT MURALE  
REMBOURRÉE**

Avec insertion de bois massif  
usé (merisier)

**MEASUREMENTS / MESURES**

	W/L in/po	D/P in/po	H in/po	COM* yd/vg	W/P lb
<b>13523-39PMCO</b>	44	3	35	1.210	29.5
<b>13523-54PMCO</b>	58	3	41	1.988	44.5
<b>13523-60PMCO</b>	65	3	41	2.169	48.5
<b>13523-78PMCO</b>	80 3/4	3	41	2.620	62.5

\* Refer to page 253 for accurate COM calculations / Référez-vous à la page 253 pour des calculs précis de COM



13504-PMCO

**WALL MOUNTED  
UPHOLSTERED  
HEADBOARD**

With self welt

**TÊTE DE LIT MURALE  
REMBOURRÉE**

*Avec cordonnet*

13504-PMCO C

**WALL MOUNTED  
UPHOLSTERED  
HEADBOARD**

With boat rope

**TÊTE DE LIT MURALE  
REMBOURRÉE**

*Avec corde de bateau*

## MEASUREMENTS / MESURES

	W/L in/po	D/P in/po	H in/po	COM* yd/vg	W/P lb
<b>13504-39PMCO</b>	44	3	30	1.458	24
<b>13504-54PMCO</b>	58	3	33	1.799	34
<b>13504-60PMCO</b>	65	3	33	2.016	37
<b>13504-78PMCO</b>	80 3/4	3	33	2.448	43
<b>13504-39PMCO C</b>	44	3	30	1.458	24
<b>13504-54PMCO C</b>	58	3	33	1.799	34
<b>13504-60PMCO C</b>	65	3	33	2.016	37
<b>13504-78PMCO C</b>	80 3/4	3	33	2.448	43

\* Refer to page 253 for accurate COM calculations / Référez-vous à la page 253 pour des calculs précis de COM

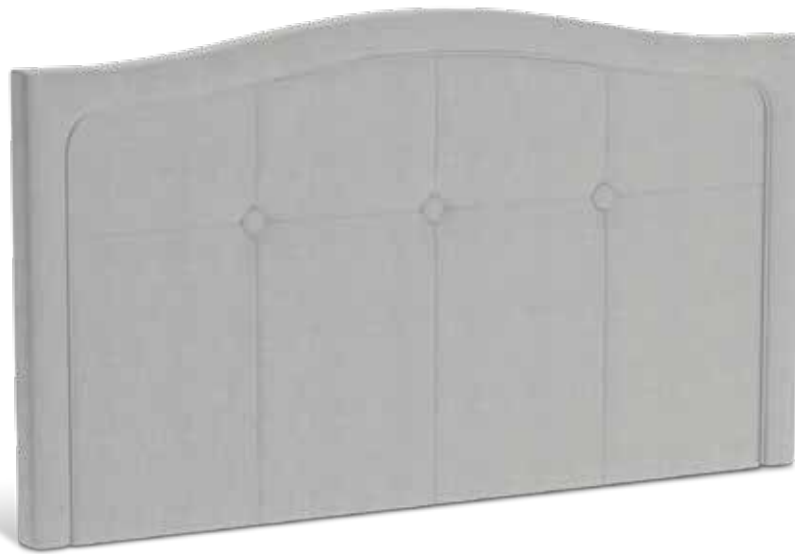

13503-PMCO

**WALL MOUNTED  
UPHOLSTERED  
HEADBOARD**

With buttons and self welt

**TÊTE DE LIT MURALE  
REMBOURRÉE**

*Avec cordonnet et boutons*

## MEASUREMENTS / MESURES

	W/L in/po	D/P in/po	H in/po	COM* yd/vg	W/P lb
<b>13503-39PMCO</b>	44	3	33	1.518	25
<b>13503-54PMCO</b>	58	3	36	2.204	36.5
<b>13503-60PMCO</b>	65	3	36	2.419	39.5
<b>13503-78PMCO</b>	80 3/4	3	36	2.896	47

\* Refer to page 253 for accurate COM calculations / Référez-vous à la page 253 pour des calculs précis de COM



Nails/Clous



NE



NF

13507-PMCO

**WALL MOUNTED  
UPHOLSTERED  
HEADBOARD**

Nails available in Silver (NE)  
or Bronze (NF)

**TÊTE DE LIT MURALE  
REMBOURRÉE**

Clous disponibles en  
Argent (NE) ou Bronze (NF)

Nail color shown/ Couleur de clous montrée: (NE)

## MEASUREMENTS / MESURES

	W/L in/po	D/P in/po	H in/po	COM* yd/vg	W/P lb
<b>13507-39PMCO</b>	44	3	33	1.454	25
<b>13507-54PMCO</b>	58	3	36	1.846	36.5
<b>13507-60PMCO</b>	65	3	36	2.042	39.5
<b>13507-78PMCO</b>	80 3/4	3	36	2.458	47

\* Refer to page 253 for accurate COM calculations / Référez-vous à la page 253 pour des calculs précis de COM



# Gastown

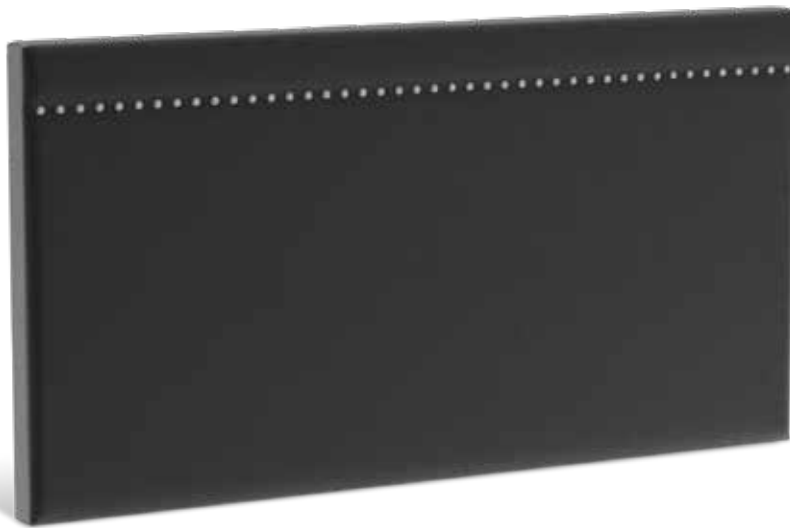

Nails/Clous



NE



NF

13511-PMCO

**WALL MOUNTED  
UPHOLSTERED  
HEADBOARD**

Nails available in Silver (NE)  
or Bronze (NF)

**TÊTE DE LIT MURALE  
REMBOURRÉE**

Clous disponibles en  
Argent (NE) ou Bronze (NF)

Nail color shown/ Couleur de clous montrée: (NE)

## MEASUREMENTS / MESURES

	W/L in/po	D/P in/po	H in/po	COM* yd/vg	W/P lb
<b>13511-39PMCO</b>	44	3	30	1.451	24
<b>13511-54PMCO</b>	58	3	33	1.833	34
<b>13511-60PMCO</b>	65	3	33	2.022	37
<b>13511-78PMCO</b>	80 3/4	3	33	2.471	43

\* Refer to page 253 for accurate COM calculations / Référez-vous à la page 253 pour des calculs précis de COM

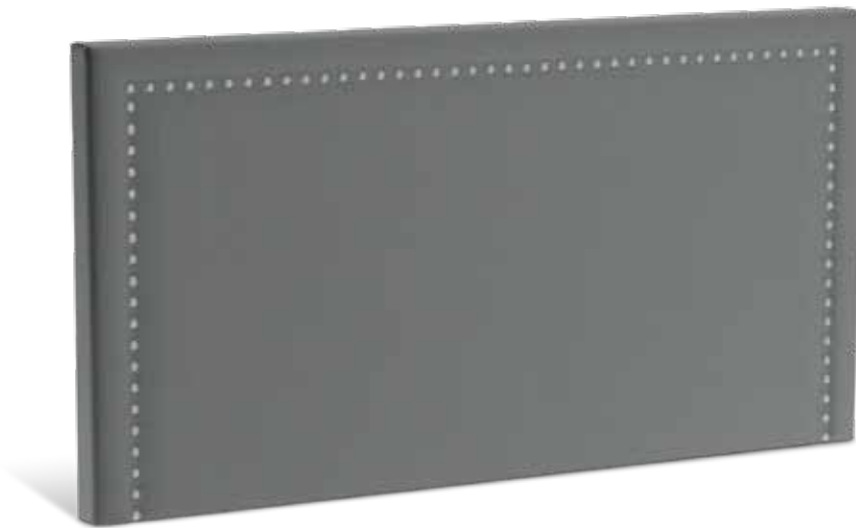

Nails/Clous



NE



NF

13510-PMCO

**WALL MOUNTED  
UPHOLSTERED  
HEADBOARD**

Nails available in Silver (NE)  
or Bronze (NF)

**TÊTE DE LIT MURALE  
REMBOURRÉE**

Clous disponibles en  
Argent (NE) ou Bronze (NF)

Nail color shown/ Couleur de clous montrée: (NE)

## MEASUREMENTS / MESURES

	W/L in/po	D/P in/po	H in/po	COM yd/vg	W/P lb
<b>13510-39PMCO</b>	44	3	30	1.451	24
<b>13510-54PMCO</b>	58	3	33	1.833	34
<b>13510-60PMCO</b>	65	3	33	2.022	37
<b>13510-78PMCO</b>	80 3/4	3	33	2.471	43

\* Refer to page 253 for accurate COM calculations / Référez-vous à la page 253 pour des calculs précis de COM

# Legend



13501-PMCO

**WALL MOUNTED  
UPHOLSTERED  
HEADBOARD**

With buttons and self welt

**TÊTE DE LIT MURALE  
REMBOURRÉE**

*Avec cordonnet et boutons*

## MEASUREMENTS / MESURES

	W/L in/po	D/P in/po	H in/po	COM* yd/vg	W/P lb
<b>13501-39PMCO</b>	44	3	30	1.333	24
<b>13501-54PMCO</b>	58	3	33	1.990	34
<b>13501-60PMCO</b>	65	3	33	2.169	37
<b>13501-78PMCO</b>	80 3/4	3	33	2.623	43

\* Refer to page 253 for accurate COM calculations / Référez-vous à la page 253 pour des calculs précis de COM

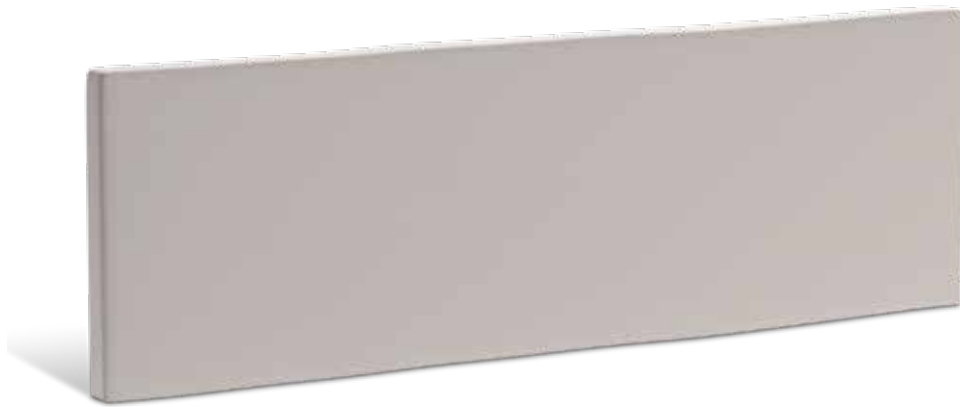

13509-PMCO

**WALL MOUNTED  
UPHOLSTERED  
HEADBOARD**

**TÊTE DE LIT MURALE  
REMBOURRÉE**

## MEASUREMENTS / MESURES

	W/L in/po	D/P in/po	H in/po	COM* yd/vg	W/P lb
<b>13509-39PMCO</b>	44	3	18 1/2	0.715	12
<b>13509-54PMCO</b>	58	3	20 1/4	1.646	20
<b>13509-60PMCO</b>	65	3	20 1/4	1.829	21.5
<b>13509-78PMCO</b>	80	3	20 1/4	2.273	30

\* Refer to page 253 for accurate COM calculations / Référez-vous à la page 253 pour des calculs précis de COM

# Namaste

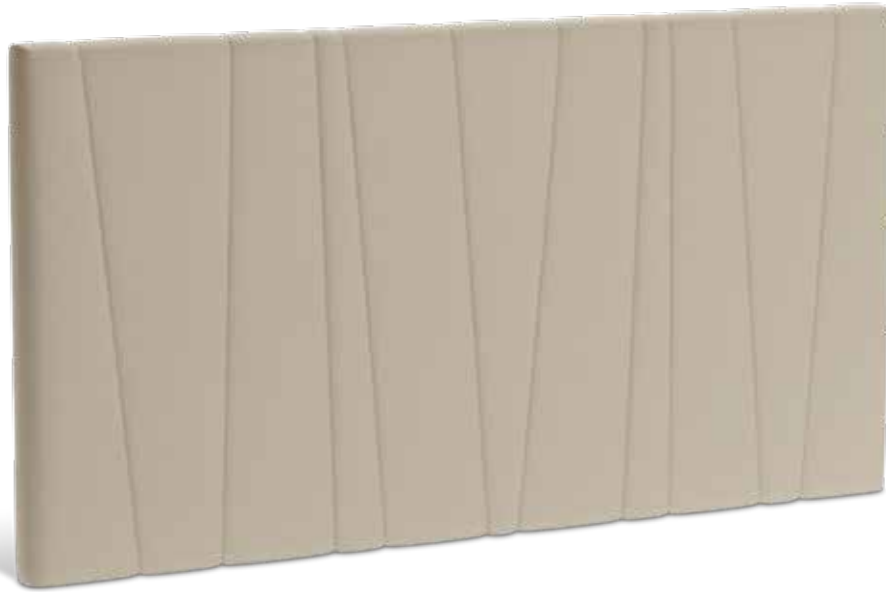

13508-PMCO

**WALL MOUNTED  
UPHOLSTERED  
HEADBOARD**

**TÊTE DE LIT MURALE  
REMBOURRÉE**

## MEASUREMENTS / MESURES

	W/L in/po	D/P in/po	H in/po	COM yd/vg	W/P lb
<b>13508-39PMCO</b>	44	3	30 1/2	1.502	24
<b>13508-54PMCO</b>	58	3	33 1/2	1.865	34
<b>13508-60PMCO</b>	65	3	33 1/2	2.041	37
<b>13508-78PMCO</b>	80 3/4	3	33 1/2	2.507	43

\* Refer to page 253 for accurate COM calculations / Référez-vous à la page 253 pour des calculs précis de COM



13518-PMCO

**WALL MOUNTED  
UPHOLSTERED  
HEADBOARD**

**TÊTE DE LIT MURALE  
REMBOURRÉE**

## MEASUREMENTS / MESURES

	W/L in/po	D/P in/po	H in/po	COM* yd/vg	W/P lb
<b>13518-39PMCO</b>	44	3	30 1/2	1.511	24
<b>13518-54PMCO</b>	58	3	33 1/2	1.918	34
<b>13518-60PMCO</b>	65	3	33 1/2	2.125	37
<b>13518-78PMCO</b>	80 3/4	3	33 1/2	2.564	43

\* Refer to page 253 for accurate COM calculations / Référez-vous à la page 253 pour des calculs précis de COM



**Uptown** 12340-78VBCO

Metal bed / *Lit de métal*

**Nanaimo** 13518-78PMCO

Wall mounted upholstered headboard  
*Tête de lit murale rembourrée*





12340-VBCO

**METAL BED**

**LIT DE MÉTAL**

Metal color shown / Couleur de métal montrée: Metallo (57)

## MEASUREMENTS / MESURES

	W/L in/po	D/P in/po	H in/po	F in/po	W/P lb
<b>12340-54VBCO</b>	54	79 7/8	16 3/8	16 3/8	40
<b>12340-60VBCO</b>	61	84 7/8	16 3/8	16 3/8	45.5
<b>12340-78VBCO</b>	76 3/4	84 7/8	16 3/8	16 3/8	48.5

# Uptown Bed with Adjustable Boxspring Support

## Lits Uptown avec support de sommier ajustable

Our designers have crafted a unique and adjustable boxspring support. With the three height adjustments it affords an impressive flexibility, accommodating coil or foam mattresses with a bunky board or a boxspring of any thickness. The three crossbars with welded central support legs are positioned where the main loads are applied to offer the optimal amount of support to your bunky board or boxspring and your mattress.

De conception unique, notre support de sommier est ajustable! Ses trois hauteurs d'ajustement offrent une grande flexibilité puisqu'il peut recevoir un matelas à ressorts ou de mousse avec un sommier ou un sommier à profil bas de n'importe quelle épaisseur. Les trois traverses et pattes de support positionnées là où les principales charges sont appliquées offrent le soutien idéal à votre sommier ou votre sommier à profil bas et votre matelas.

**FULL, QUEEN AND KING SIZE BEDS**  
**LITS 54", 60" ET 78"**



### FEATURES

- Can be used alone or combined with one of our upholstered wall mounted headboards
- Side rails made of top-quality steel
- 3 metal crossbars with welded central support legs
- 3 large adjustable flat glides: fit uneven floors and prevent floor damage
- 3 height adjustments
- Must be used with a mattress in combination with a boxspring or a bunky board
- Bunky board #85500-CO sold separately
- Side rails painted in the same metal finish than the rest of the bed
- Available in Full, Queen and King sizes
- 5 year limited commercial warranty
- To order a metal bed with adjustable boxspring support, add VB at the end of the code (ex: 12340-60VBCO)

### CARACTÉRISTIQUES

- Peut être utilisé seul ou combiné à un de nos panneaux muraux rembourrés
- Fers angles en acier de première qualité
- 3 traverses de métal avec pattes de support centrales soudées
- 3 grands glisseurs plats avec vis d'ajustement micrométrique: s'adapte aux planchers inégaux et prévient les bris de plancher
- 3 hauteurs d'ajustement
- Doit être utilisé avec un sommier ou un sommier à profil bas en combinaison avec un matelas
- Sommier à profil bas #85500-CO vendu séparément
- Fers angles peints de la même couleur que le reste du lit
- Disponible en 54", 60" et 78"
- Garantie commerciale limitée de 5 ans
- Pour commander un lit de métal avec support de sommier ajustable, ajoutez VB à la fin du code (ex : 12340-60VBCO)

**Lowest position**  
**Position la plus basse**

7" 4 1/2"

For a boxspring or a bunky board and a mattress  
Pour un sommier ou un sommier à profil bas et un matelas

Shown with a boxspring  
Montré avec un sommier

**Middle position**  
**Position du centre**

9 1/2" 7"

For a boxspring or a bunky board and a mattress of 12" or more  
Pour un sommier ou un sommier à profil bas et un matelas de 12" ou plus

Shown with a bunky board  
Montré avec un sommier à profil bas

**Highest position**  
**Position la plus haute**

14" 11 1/2"

For a boxspring or a bunky board and a mattress of 12" or less  
Pour un sommier ou un sommier à profil bas et un matelas de 12" ou moins

Shown with a bunky board  
Montré avec un sommier à profil bas

## Uptown Twin Bed with Versatile Mattress Support *Lit Simple Uptown avec support de matelas Versatile*

Our designers have crafted a unique—and versatile—mattress support. With three height adjustments, it affords an impressive flexibility, accommodating coil or foam mattresses with or without a boxspring. And its flat platform gives the mattress the optimal amount of support.

*De conception unique, notre support de matelas est versatile ! Ses trois hauteurs d'ajustement offrent une grande flexibilité puisqu'il peut recevoir un matelas à ressorts ou de mousse, avec ou sans sommier. Sa plateforme lisse offre le soutien idéal au matelas.*



### FEATURES

- Can be used alone or combined with one of our upholstered wall mounted headboards
- Three height adjustments
- Accommodates coil or foam mattresses
- With or without a boxspring
- All metal colors available
- Bed frame painted in the same metal finish than the rest of the bed
- No support leg under the bed to facilitate floor maintenance
- Constructed of extremely sturdy top-quality steel
- 5 year limited commercial warranty

### CARACTÉRISTIQUES

- *Peut être utilisé seul ou combiné à un de nos panneaux muraux rembourrés*
- *Trois hauteurs d'ajustement*
- *Permet de recevoir un matelas à ressorts ou de mousse*
- *Avec ou sans sommier*
- *Disponible dans toutes les couleurs de métal*
- *Sommier peinturé de la même couleur que le reste du lit*
- *Aucune patte support sous le lit afin de faciliter l'entretien du plancher*
- *Structure en métal faite d'acier de première qualité extrêmement résistant*
- *Garantie commerciale limitée de 5 ans*

### MEASUREMENTS / MESURES

	W/L in/po	D/P in/po	H in/po	F in/po	W/P lb
<b>12340-39CO</b>	40 1/4	79 3/4	16 3/8	16 3/8	75

**TWIN SIZE BED**  
**LIT 39"**

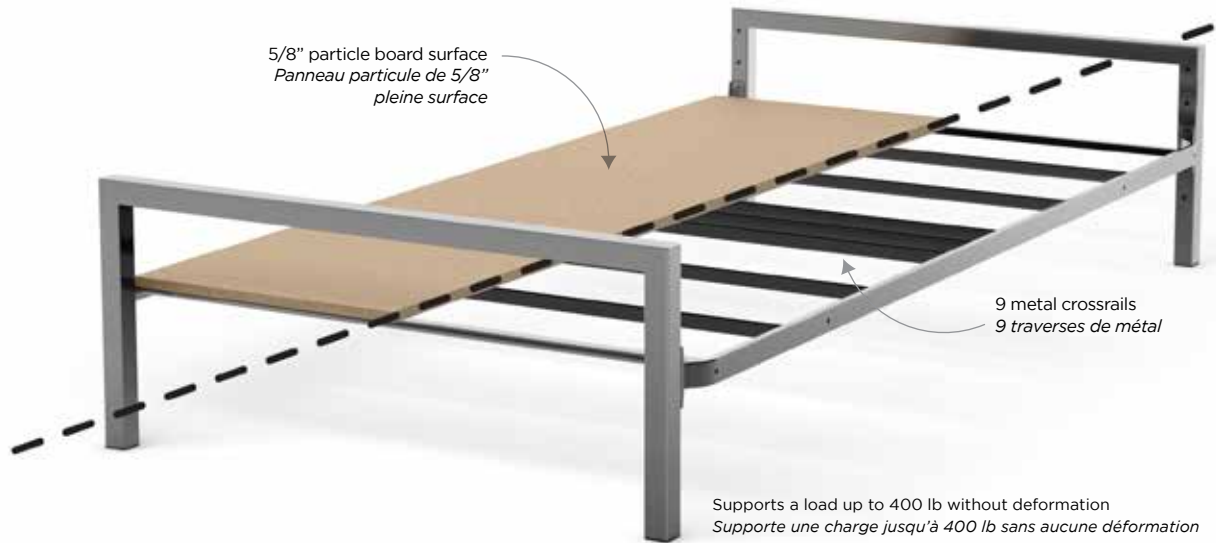

**MATTRESS SUPPORT ADJUSTMENT HEIGHTS**  
**HAUTEURS D'AJUSTEMENT DU SUPPORT DE MATELAS**

**LOWEST POSITION**  
**POSITION LA PLUS BASSE**

For a mattress and boxspring  
*Pour un ensemble de matelas et sommier*

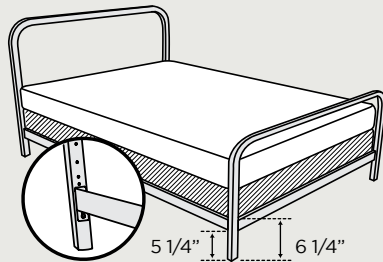

**MIDDLE POSITION**  
**POSITION DU CENTRE**

For a mattress of 12" or more  
*Pour un matelas de 12" ou plus*

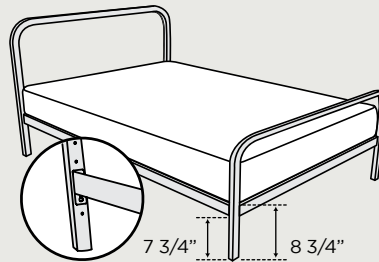

**HIGHEST POSITION**  
**POSITION LA PLUS HAUTE**

For a mattress of 12" or less  
*Pour un matelas de 12" ou moins*

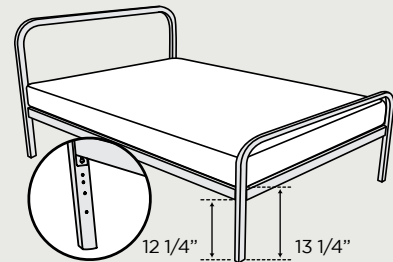

**1** = Distance from the floor to the **bottom** of the mattress support  
*Distance entre le sol et le **dessous** du support de matelas*

**2** = Distance from the floor to the **top** of the mattress support  
*Distance entre le sol et le **dessus** du support de matelas*

# Bunky Board

## Sommier à profil bas

### BUNKY BOARD FEATURES

- Low profile boxspring of 1 1/2" high (raises a mattress without changing the look)
- Sturdy wood frame (fir and spruce) wrapped in quality fabric
- Built without glue nor formaldehyde
- Supports coil or memory foam mattresses of any thickness
- Prevents sagging and increases mattress longevity
- Allows the mattress to breathe
- 5 year limited commercial warranty
- No assembly required
- Made in Canada

### CARACTÉRISTIQUES DU SOMMIER À PROFIL BAS

- Sommier à profil bas de 1 1/2" d'épaisseur (soulève le matelas sans changer le look)
- Cadre en bois robuste (sapin et épinette) enveloppé dans un tissu de qualité
- Construction sans colle ni formaldéhyde
- Le sommier à profil bas supporte les matelas à ressorts ou les matelas mousse mémoire de toutes épaisseurs
- Empêche l'affaissement et augmente la longévité du matelas
- Permet au matelas de respirer
- Garantie commerciale limitée de 5 ans
- Aucun assemblage requis
- Fait au Canada



### BUNKY BOARD AVAILABLE IN: SOMMIER À PROFIL BAS DISPONIBLE EN :

Full size bed / Lit 54" **85500-54CO**  
 Queen size bed / Lit 60" **85500-60CO**  
 King size bed / Lit 78" **85500-78CO** (Bunky board in 2 pieces  
 Sommier à profil bas en 2 pièces)

### MEASUREMENTS / MESURES

	W/L in/po	D/P in/po	H in/po	W/P lb
<b>85500-54CO</b>	53	74	1 1/2	24.5
<b>85500-60CO</b>	60	79	1 1/2	29
<b>85500-78CO</b>	76	79	1 1/2	37



# 5 Year Limited Warranty

## COMMERCIAL 5 YEAR WARRANTY

AMISCO hereby warrants the welding and metal structure of its products for a period of five (5) years of indoor commercial or institutional use. Wood products and upholstered products have a one (1) year limited warranty. Metal, wood and upholstered products are warranted against damage caused by material and workmanship defects, occurring during a normal use and under the conditions for which the products are designed.

The warranty does not cover:

- Normal wear of paint, lacquer or upholstered covering;
- Variations in surface materials (ex: matching grains, color and textures across different substrates or lots);
- Decorative features, glass components, glides and other accessories;
- Defects and damage resulting from improper use, care or assembly, from unauthorized repair or alteration or from negligence.

Under this warranty, AMISCO will, at its discretion, repair or replace the defective part at no cost during the first year, except for transportation, handling and shipping costs which will be charged to the purchaser. After the first year, the cost of replacement components is 1/5 of their price times the number of years of use, plus handling and shipping. The replacement parts are included in this warranty for the remainder of the original warranty period.

This is a limited warranty, any defect not specifically covered herein is excluded. Where allowed under the law, AMISCO disclaims liability for all special, incidental and consequential damage.

## CLAIMS AND MERCHANDISE RETURNS

If parts are missing or received damaged, contact Amisco within 30 days from your purchase date. All warranty claims must be sent in writing to AMISCO together with the original or photocopy of the original purchase receipt and the following justification pieces:

- Picture of the whole product
- Picture of the damage or defect on the product
- Picture of the product individual identification label (when applicable).

AMISCO reserves the right to ascertain the basis for a request. Defective merchandise may not be returned until receipt of AMISCO'S written authorization and shipping instructions are given. AMISCO reserves the right to replace merchandise deemed defective with similar merchandise of same value if original merchandise is no longer available.

## PAINT FINISHES

All AMISCO metal furniture are powder coated, which provides a durable and environmental friendly finish for indoor use.

## SEMI-TRANSPARENT FINISHES HARLEY (51) AND OXIDADO (52)

AMISCO'S unique finishes assures you that no two pieces will ever be identical since through these finishes you are able to see details such as welding lines, sanding and other techniques bearing the touch of AMISCO'S many skilled metal craftsmen. A certain amount of discoloration of the steel in various spots is a natural occurrence in this process and should not be considered a defect.

To view additional information, please visit [www.amiscocontract.com](http://www.amiscocontract.com)

- Order Information
- New Accounts Payment
- Funds & Fabric Shipping
- Minimum Orders
- COM
- Terms and Conditions

# Garantie limitée de 5 ans

## GARANTIE COMMERCIALE LIMITÉE DE 5 ANS

AMISCO, par la présente, garantit la soudure et la structure de métal de ses produits pour une période de cinq (5) ans en usage intérieur commercial ou institutionnel. Les produits et composants en bois et rembourrés ont une garantie limitée d'un (1) an. Les produits de métal, de bois et les produits rembourrés sont garantis contre tous bris causés par un défaut de matériaux et de main-d'œuvre, survenant au cours d'un usage normal et dans des conditions pour lesquelles les produits sont destinés.

La garantie ne couvre pas:

- l'usure normale de la peinture, de la laque ou du tissu de recouvrement;
- les variations de finition (ex: faire correspondre le grain, la couleur et les textures dans différents substrats ou lots);
- les éléments décoratifs, les composants de verre, les glisseurs et autres accessoires;
- les défauts ou bris résultant d'un usage, entretien ou assemblage inapproprié, de modifications ou réparations non autorisées ou de négligence.

En vertu de cette garantie, AMISCO, à sa discrétion, réparera ou remplacera les pièces défectueuses sans frais pendant la première année, à l'exception des frais de transport, de manutention et d'expédition qui seront facturés à l'acheteur. Après la première année, le coût des pièces de remplacement est le 1/5 de leur prix multiplié par le nombre d'années d'utilisation, plus les frais de manutention et d'expédition. Les pièces de remplacement sont incluses dans cette garantie pour le reste de la période de la garantie originale.

La présente garantie est limitée, tous défauts non spécifiquement mentionnés sont exclus. Lorsque permis en vertu de la loi, AMISCO renonce à toute responsabilité pour tout dommage direct ou indirect, incident ou conséquent.

## RÉCLAMATIONS ET RETOURS DE MARCHANDISE

Si certaines pièces sont manquantes ou reçues endommagées, contactez AMISCO dans les 30 jours suivant votre achat. Toutes les réclamations sous garantie doivent être envoyées chez AMISCO par écrit avec l'original ou une photocopie de l'original de la facture ainsi que les pièces justificatives suivantes:

- Photo d'ensemble du produit
- Photo du dommage ou défaut sur le produit
- Photo de l'étiquette unique du produit (si applicable)

AMISCO se réserve le droit de vérifier le fondement de la réclamation. Les produits défectueux ne doivent pas être retournés chez AMISCO avant d'avoir reçu une autorisation écrite et les instructions d'expédition. AMISCO se réserve le droit de remplacer des produits considérés défectueux par des produits similaires ou de même valeur si les produits originaux ne sont plus disponibles.

## REVÊTEMENTS DE PEINTURE

Les produits de métal AMISCO sont recouverts d'une peinture en poudre cuite, qui leur confère un fini durable, respectueux de l'environnement et adapté à une utilisation intérieure.

## FINIS SEMI-TRANSPARENTS HARLEY (51) ET OXIDADO (52)

Grâce à ces revêtements, il n'existe pas deux meubles identiques. En effet, en laissant voir les cordons de soudure, le sablage et autres procédés, ce fini met en valeur la finesse et l'originalité des artisans d'AMISCO. Une certaine décoloration du métal à divers endroits ne devrait pas être considérée comme une imperfection.

Veuillez consulter [www.amiscocontract.com](http://www.amiscocontract.com) pour l'information concernant:

- Les commandes
- L'ouverture de comptes
- Les avances et l'envoi de tissu
- Les quantités minimum
- Le COM
- Les termes et conditions



# Metal Colors

## Couleurs de métal

### OPAQUE FINISHES

#### FINIS OPAQUES



24 Magnetite



25 Black coral/Noir corail



27 Sun gold

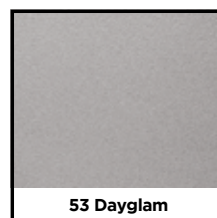

53 Dayglam

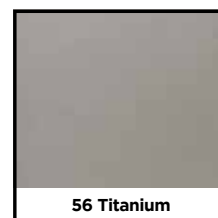

56 Titanium

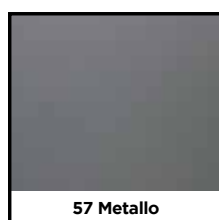

57 Metallo



58 Sienna



61 Pure



68 Vanilla

### HAMMERED FINISHES

#### FINIS MARTELÉS

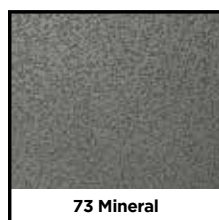

73 Mineral



74 Falcon



75 Cobrizo

*The texture and the crater size may vary when compared to the color sample, or between products.*

*La texture et la taille des cratères peuvent varier par rapport à l'échantillon, et d'un produit à l'autre.*

### SEMI-TRANSPARENT FINISHES

#### FINIS SEMI-TRANSPARENTS



51 Harley



52 Oxidado

### NAIL COLORS

#### COULEURS DE CLOUS



NF Silver /Argent



NE Bronze



## Semi-Transparent Finishes Characteristics *Particularités des finis semi-transparentes*

The inherent characteristics of these finishes allow the darkening of the construction welds and seams to show through, which makes each piece truly unique.

*La particularité des finis semi-transparentes est de laisser entrevoir le noircissement créé par le procédé de soudure, ce qui rend chaque pièce vraiment unique.*

### **Color variations/ Variations dans la couleur**

Paint thickness variation is inherent to our paint application process. The differences in paint thickness cause color variations, which may vary from a light copper tint to a dark brown on the same product. These color changes provide to this finish a warm and unique look.

*Des variations d'épaisseurs de peinture sont inhérentes à notre procédé d'application de peinture. Ces dernières engendrent des variations de couleurs, qui peuvent aller d'une teinte claire et cuivrée à un brun foncé sur un même produit. Ces nuances de couleurs rendent ce fini très chaleureux et unique.*

### **Weld seam along tubes/ Soudures le long des tubes**

A continuous black line may appear along a tube. This is the area where the steel was welded to become a tube. The tube weld seam may appear on any given face of a tube or of a product.

*Une ligne plus foncée peut être apparente tout le long d'un tube. C'est l'endroit où l'acier a été soudé pour devenir un tube. La ligne de soudure sur les tubes peut être apparente sur n'importe quelle face du tube ou du produit.*

### **Visible welds/ Soudures apparentes**

When welding, metal heats up and darkens. Dark spots may be visible around welds, as well as on the face of a sheet metal part opposite to a weld.

*En soudant, le métal chauffe et se noircit. Des taches foncées peuvent être apparentes autour des soudures, ainsi que sur le côté opposé à une soudure sur une tôle.*

Buffer marks  
*Traces de sablage*



Spots on steel  
*Taches sur l'acier*



# Wood Colors

## Couleurs de bois

---

**SOLID WOOD ACCENTS AND WOOD VENEER (BIRCH) 5% SHEEN**  
**ACCENTS EN BOIS MASSIF (MERISIER) BRILLANCE DE 5%**

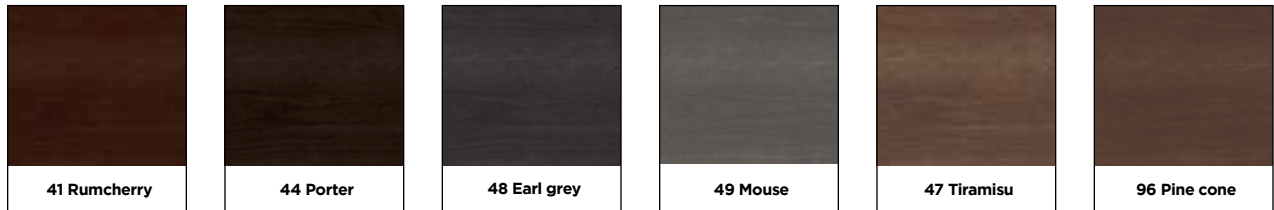

---

**SOLID WOOD ACCENTS (LARCH) 5% SHEEN**  
**ACCENTS EN BOIS MASSIF (MÉLÈZE) BRILLANCE DE 5%**



Larch exclusively available on the 30438 Risley accent chair / *Mélèze uniquement disponible sur le fauteuil d'accent Risley 30438*

---

**DISTRESSED SOLID WOOD SEATS, BACKRESTS, ACCENTS AND TABLETOPS (BIRCH) 5% SHEEN**  
**SIÈGES, DOSSIERS, ACCENTS ET DESSUS DE TABLE EN BOIS MASSIF USÉ (MERISIER) BRILLANCE DE 5%**

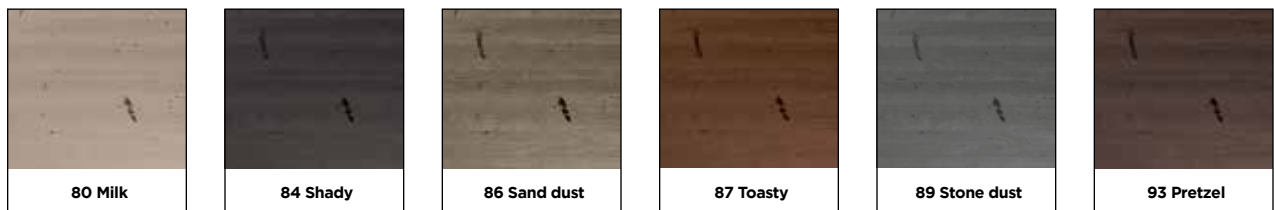

---

**SOLID WOOD TABLETOPS (ASH) 5% SHEEN**  
**DESSUS DE TABLE EN BOIS MASSIF (FRÈNE) BRILLANCE DE 5%**

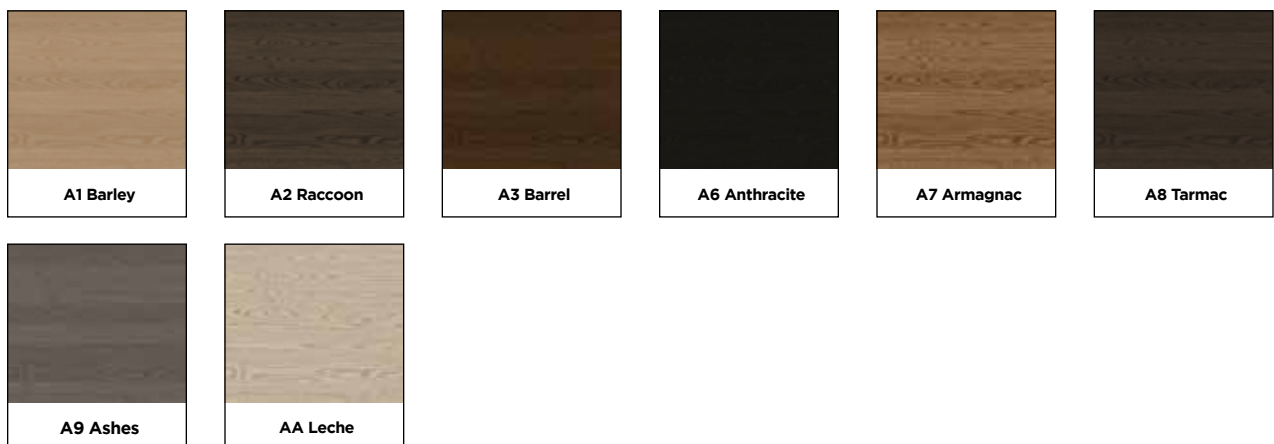

## **Distressed Solid Birch Characteristics** **Caractéristiques du merisier massif usé**

Celebrating character marks, knots and contrasting wood grain, distressed solid birch blends incredibly well with steel, providing an authentic and unique look to every product. Distressed solid birch is only available when mentioned in the product description.

*Faisant l'éloge des nœuds, des marques de caractère et du grain de bois contrasté, le merisier massif usé s'agence incroyablement bien avec le métal, conférant un look unique et authentique à chaque produit. Le merisier massif usé est uniquement disponible lorsque mentionné dans le descriptif de produit.*

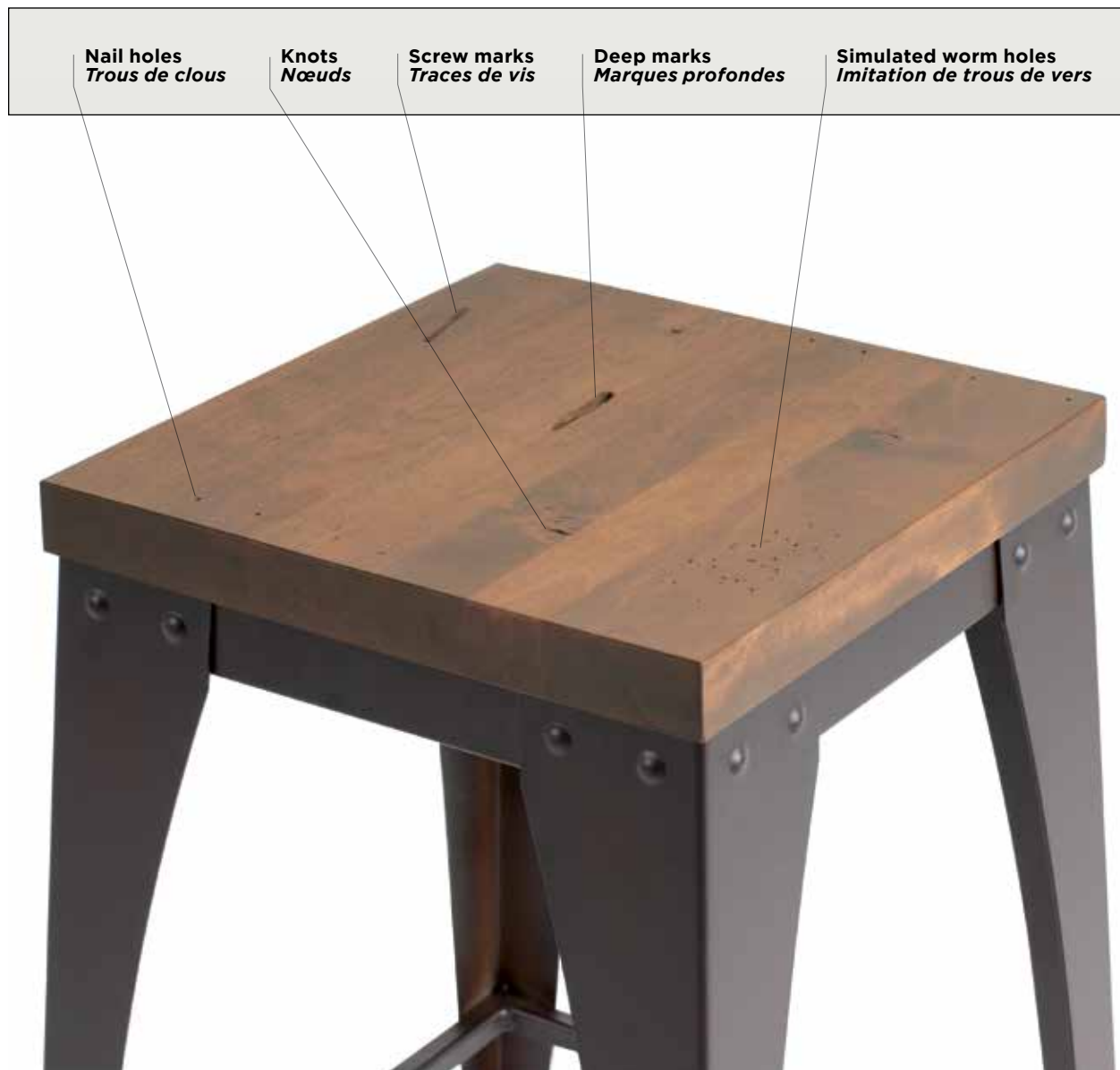

# Coverings / Recouvrements

## 3 Covering Options

- **COM** : We gladly welcome customer own material
- **In House Collection** : Our selection includes 27 colors of plain vinyl. See amiscocontract.com
- **Mayer Fabrics program** : Our partnership allows us to quote, source and provide any covering from Mayer Fabrics. [www.mayerfabrics.com](http://www.mayerfabrics.com)

## 3 Options de recouvrements

- **COM** : Nous acceptons les recouvrements que vous nous ferez parvenir
- **Notre collection maison** : Notre sélection comprend 27 couleurs de vinyle uni. amiscocontract.com
- **Programme Mayer Fabrics** : Notre partenariat nous permet de fournir les prix et d'assurer l'approvisionnement de n'importe quel recouvrement offert chez Mayer Fabrics. [www.mayerfabrics.com](http://www.mayerfabrics.com)

## COM Calculations

### CHAIRS AND STOOLS (PLAIN COVERING ONLY)

1. Multiply quantity by COM factor indicated in the measurements grid of the product sheet
2. Round up the quantity of yards calculated
3. Add additional yardage:
  - 12 - 50 seats or backrests: add 2 yards
  - 51 - 200 seats or backrests: add 3 yards
  - 201 + seats or backrests: add 4 yards

**Please contact us for patterned covering.**

## Calculs de COM

### CHAISES ET TABOURETS (UNIQUEMENT POUR LES RECOUVREMENTS UNIS)

1. Multiplier le nombre de produits par le facteur COM indiqué dans le tableau des mesures de la fiche produit
2. Arrondir la quantité de verges calculée au nombre entier supérieur
3. Ajouter la quantité suivante :
  - 12 - 50 sièges ou dossiers: ajouter 2 verges
  - 51 - 200 sièges ou dossiers: ajouter 3 verges
  - 201 + sièges ou dossiers: ajouter 4 verges

**Veillez nous contacter pour le calcul d'un recouvrement à motif.**

# Numerical Index / *Index numérique*



**12340-39CO LIT UPTOWN**  
P. 245



**12340-VBCO LIT UPTOWN**  
P. 242, 243, 244



**13501-PMCO LEGEND**  
P. 230, 238



**13503-PMCO CROCUS**  
P. 234



**13504-PMCO BREEZE**  
P. 233



**13504-PMCO BREEZE**  
P. 233



**13507-PMCO ELEGANCE**  
P. 235



**13508-PMCO NAMASTE**  
P. 240



**13509-PMCO MURO**  
P. 239



**13510-PMCO GRANVILLE**  
P. 237



**13511-PMCO GASTOWN**  
P. 236



**13518-PMCO NANAIMO**  
P. 241, 242



**13523-PMCO BOUNTY**  
P. 232



**21145-CO RUPERT**  
P. 187



**30103-CO USUB PAYTON**  
P. 143



**30137-CO USUB JONAS**  
P. 117



**30223-CO DSDB DEXTER**  
P. 2, 94



**30223-CO USDB DEXTER**  
P. 94



**30227-CO DSDB ANGELINA**  
P. 22, 61



**30237-CO USUB JOAN**  
P. 117, 188



**30263-CO DSDB ARCHITECT**  
P. 15, 65



**30263-CO USDB ARCHITECT**  
P. 65



**30303-CO USMB WASHINGTON**  
P. 10, 170



**30330-CO USUB WEBBER**  
P. 171



**30408-CO DSNB UPRIGHT**  
P. 178



**30408-CO USNB UPRIGHT**  
P. 178



**30409-CO DSNB DRYDEN**  
P. 179



**30409-CO USNB DRYDEN**  
P. 179



**30410-CO DSNB UPRIGHT**  
P. 15, 178



**30410-CO USNB UPRIGHT**  
P. 178



**30419-CO DSNB DRYDEN**  
P. 179



**30419-CO USNB DRYDEN**  
P. 179



**30425-CO USUB MUNICH**  
P. 189



**30435-CO USUB SINGAPORE**  
P. 8, 18, 190



**30472-CO USUB PABLO**  
P. 177



**30473-CO USUB PABLO**  
P. 177



**30474-CO USUB MONROE**  
P. 176



**30478-CO USUB MONROE**  
P. 176



**30529-CO DSDB SNYDER**  
P. 157



**30529-CO USDB SNYDER**  
P. 157



**30530-CO USUB ELMIRA**  
P. 102



**30534-CO USUB WESTON**  
P. 4, 174



**30535-CO USUB EASTON**  
P. 6, 96



**30536-CO USUB BRIXTON**  
P. 75



**30560-CO USUB GRISSOM**  
P. 18, 108



**30561-CO USUB GRISSOM PLUS**  
P. 108



**30563-CO DSMB ARCHITECT**  
P. 65



**30563-CO USMB ARCHITECT**  
P. 65



**30573-CO USUB DARLENE**  
P. 92



**30574-CO USUB DARCY**  
P. 24, 91



**30575-CO USUB BRIDGET**  
P. 22, 74



**30576-CO USUB REGENT**  
P. 149



**30593-CO DSMB LAUREN**  
P. 125



**30593-CO USMB LAUREN**  
P. 125



**31661-CO DSDB RALLY**  
P. 148



**31661-CO USDB RALLY**  
P. 148



**31669-CO DSDB SYMMETRY**  
P. 162



**31669-CO USDB SYMMETRY**  
P. 162



**COREY 34560-CO USUB**  
P. 26, 87



**JACOB 34572-CO USUB**  
P. 114



**35198-CO DSMB EDWIN**  
P. 97



**35198-CO USMB EDWIN**  
P. 97



**35210-CO USDB ELEANOR**  
P. 99



**35210-CO USWB ELEANOR**  
P. 99



**35211-CO USDB CYNTHIA**  
P. 89



**35211-CO USWB CYNTHIA**  
P. 90



**35214-CO DSDB KYLE**  
P. 120



**35214-CO USDB KYLE**  
P. 120





**35214-CO USWB KYLE**  
P. 120



**35219-CO DSDB ANNABELLE**  
P. 62



**35219-CO USDB ANNABELLE**  
P. 62



**35219-CO USWB ANNABELLE**  
P. 62



**35304-CO USUB PABLO**  
P. 11, 26, 139



**35305-CO USUB LEO**  
P. 139



**35308-CO USUB PEDRO**  
P. 139



**35309-CO USUB ALTO**  
P. 139



**35312-CO USUB PERRY**  
P. 16, 144



**35313-CO USUB LARRY**  
P. 144



**35316-CO USWB COLETTE**  
P. 85



**35318-CO USUB PENNY**  
P. 144



**35319-CO USUB PACEY**  
P. 144



**35404-CO USUB MONROE**  
P. 131



**35405-CO USUB MITCHELL**  
P. 131



**35408-CO USUB MELROSE**  
P. 131



**35409-CO USUB MARLON**  
P. 131



**35410-CO USDB ELEANOR**  
P. 99



**35410-CO USWB ELEANOR**  
P. 99



**35411-CO USDB CYNTHIA**  
P. 89



**35411-CO USWB CYNTHIA**  
P. 90



**35414-CO USDB KYLE**  
P. 121



**35414-CO USWB KYLE**  
P. 121



**35419-CO USDB ANNABELLE**  
P. 63



**35419-CO USWB ANNABELLE**  
P. 63



**39123-CO DSMB CRESCENT**  
P. 88



**39123-CO USMB CRESCENT**  
P. 88



**39124-CO DSMB TORI**  
P. 163



**39124-CO USMB TORI**  
P. 163



**39132-CO USUB OPUS**  
P. 136



**39144-CO DSMB TORI**  
P. 163



**39144-CO USMB TORI**  
P. 163



**39151-CO USMB MARCUS**  
P. 127



**39154-CO DSMB OWEN**  
P. 137



**39154-CO USMB OWEN**  
P. 137



**39202-CO USWB HINT**  
P. 112



**39268-CO DSDB BEAN**  
P. 70



**39268-CO USDB BEAN**  
P. 70



**39568-CO DSMB BEAN**  
P. 70



**39568-CO USMB BEAN**  
P. 70



**39570-CO USUB WILBUR**  
P. 175



**39667-CO DSMB CLUB**  
P. 84



**39667-CO USMB CLUB**  
P. 84



**40033-CO USNB NATHAN**  
P. 133



**40034-CO DSNB RYAN**  
P. 154



**40034-CO USNB RYAN**  
P. 154



**40035-CO USNB MILLER**  
P. 129



**40038-CO DSNB BRADLEY**  
P. 73



**40038-CO USNB BRADLEY**  
P. 73



**40039-CO DSNB AARON**  
P. 57



**40039-CO USNB AARON**  
P. 57



**40103-CO USUB PAYTON**  
P. 143



**40112-CO DSMB ALBERTO**  
P. 12, 59



**40112-CO USMB ALBERTO**  
P. 59



**40132-CO USUB OPUS**  
P. 136



**40202-CO USWB HINT**  
P. 112



**40227-CO DSDB ANGELINA**  
P. 22, 61



**40263-CO DSDB ARCHITECT**  
P. 14, 66



**40263-CO USDB ARCHITECT**  
P. 66



**40264-CO DSDB UPRIGHT**  
P. 169



**40264-CO USDB UPRIGHT**  
P. 20, 169



**40303-CO USMB WASHINGTON**  
P. 10, 170



**40323-CO DSDB DEXTER**  
P. 2, 94



**40323-CO USDB DEXTER**  
P. 94



**40372-CO USUB PABLO**  
P. 177



**40491-CO DSMB GATLIN**  
P. 106



**40491-CO USMB GATLIN**  
P. 106



**40494-CO USUB KRIS**  
P. 119



**40563-CO DSMB ARCHITECT**  
P. 66



**40563-CO USMB ARCHITECT**  
P. 66



**40573-CO USUB DARLENE**  
P. 24, 92



**40574-CO USUB DARCY**  
P. 91



**40593-CO DSMB LAUREN**  
P. 125



**40593-CO USMB LAUREN**  
P. 125



**40614-CO DSMB UPLIFT**  
P. 168



**40614-CO USMB UPLIFT**  
P. 168



**40661-CO DSDB RALLY**  
P. 148



**40661-CO USDB RALLY**  
P. 148



**41268-CO DSDB BEAN**  
P. 71



**41268-CO USDB BEAN**  
P. 71



**41330-CO USUB WEBBER**  
P. 171



**41402-CO USWB HISTORIAN**  
P. 113



**41406-CO USWB MADISON**  
P. 126



**41410-CO USDB ELEANOR**  
P. 100



**41410-CO USWB ELEANOR**  
P. 100



**41411-CO USDB CYNTHIA**  
P. 89



**41411-CO USWB CYNTHIA**  
P. 90



**41414-CO DSDB KYLE**  
P. 122



**41414-CO USDB KYLE**  
P. 122



**41414-CO USWB KYLE**  
P. 122



**41419-CO DSDB ANNABELLE**  
P. 64



**41419-CO USDB ANNABELLE**  
P. 64



**41419-CO USWB ANNABELLE**  
P. 64



**41430-CO USUB CARDIN**  
P. 81



**41431-CO USUB AKERS**  
P. 58



**41437-CO USUB JONAS**  
P. 117



**41442-CO USUB RONNY**  
P. 151



**41443-CO USMB DEREK**  
P. 93



**41444-CO USNB BRYCE**  
P. 79



**41445-CO USUB BARRY**  
P. 69



**41451-CO USMB MARCUS**  
P. 127



**41454-CO USMB OWEN**  
P. 137



**41466-CO USMB MEADOW**  
P. 128



**41474-CO USUB STATEN**  
P. 158



**41475-CO USUB TOWER**  
P. 164



**41477-CO DSMB NEST**  
P. 134



**41477-CO USMB NEST**  
P. 134



**41488-CO USMB GARDEN**  
P. 105



**41493-CO DSMB TURBO**  
P. 166



**41493-CO USMB TURBO**  
P. 166



**41498-CO DSMB EDWIN**  
P. 98



**41498-CO USMB EDWIN**  
P. 98



**41510-CO USUB OXFORD**  
P. 138



**41516-CO USMB WELLINGTON**  
P. 172



**41522-CO USWB BOURBON**  
P. 72



**41526-CO USUB RUSSELL**  
P. 153



**41527-CO DSMB JETSON**  
P. 115



**41527-CO USMB JETSON**  
P. 115



**41528-CO DSMB KENT**  
P. 118



**41528-CO USMB KENT**  
P. 118



**41529-CO USDB SNYDER**  
P. 157



**41529-CO DSDB SNYDER**  
P. 157



**41530-CO USUB ELMIRA**  
P. 102



**41534-CO USUB WESTON**  
P. 4, 174



**41535-CO USUB EASTON**  
P. 6, 96



41536-CO USUB BRIXTON  
P. 75



41537-CO USUB RADCLIFF  
P. 147



41540-CO USUB DUNCAN  
P. 95



41542-CO USUB BROWSER  
P. 78



41543-CO DSMB RENDER  
P. 150



41543-CO USMB RENDER  
P. 150



41545-CO USUB STINSON  
P. 159



41548-CO USUB MINTO  
P. 130



41549-CO DSMB CENTURY  
P. 82



41549-CO USMB CENTURY  
P. 82



41557-CO USUB RADCLIFF  
P. 147



41560-CO USUB GRISSOM  
P. 18, 108



41567-CO DSDB JETSON  
P. 116



41567-CO USDB JETSON  
P. 116



41568-CO DSMB BEAN  
P. 71



41568-CO USMB BEAN  
P. 71



41570-CO USUB WILBUR  
P. 175



41576-CO USUB REGENT  
P. 149



41578-CO USUB WEMBLEY  
P. 173



41585-CO USUB BROCKTON  
P. 77



41586-CO USUB REGENT  
P. 149



41624-CO DSMB SCROLLER  
P. 155



41624-CO USMB SCROLLER  
P. 155



41663-CO DSDB UNITY  
P. 167



41663-CO USDB UNITY  
P. 167





**41666-CO DSMB UNITY**  
P. 167



**41666-CO USMB UNITY**  
P. 167



**41667-CO DSMB CLUB**  
P. 84



**41667-CO USMB CLUB**  
P. 84



**41669-CO DSDB SYMMETRY**  
P. 162



**41669-CO USDB SYMMETRY**  
P. 162



**42402-CO USNB PHYLO**  
P. 146



**42414-CO DSNB GRACE**  
P. 107



**42414-CO USNB GRACE**  
P. 107



**42437-CO USNB CLOCK**  
P. 83



**42442-CO USNB RUDY**  
P. 152



**42444-CO DSNB SWICE**  
P. 161



**42444-CO USNB SWICE**  
P. 161



**42460-CO DSNB BUTTON**  
P. 80



**42460-CO USNB BUTTON**  
P. 80



**42493-CO DSNB CONNOR**  
P. 86



**42493-CO USNB CONNOR**  
P. 86



**42496-CO USNB SWAN**  
P. 160



**42534-CO USNB NOX**  
P. 135



**42563-CO DSNB ARCHITECT**  
P. 67



**42563-CO USNB ARCHITECT**  
P. 67



**42564-CO DSNB UPRIGHT**  
P. 169



**42564-CO USNB UPRIGHT**  
P. 169



**42593-CO USNB ANDERS**  
P. 60



**42614-CO DSNB UPLIFT**  
P. 168





**42614-CO USNB UPLIFT**  
P. 168

**44412-CO USUB PARKER**  
P. 141

**44443-CO USUB TRAVIS**  
P. 165

**44501-CO USNB SINCLAIR**  
P. 156

**44542-CO USUB ELLER**  
P. 101



**44560-CO USUB COREY**  
P. 87

**44570-CO USMB LARKIN**  
P. 124

**44572-CO USUB JACOB**  
P. 114

**44573-CO USUB HARTMAN**  
P. 111

**44661-CO DSDB GUSTAVSON**  
P. 109



**44661-CO DSDB GUSTAVSON**  
P. 109

**45312-CO USUB PERRY**  
P. 145

**45313-CO USUB FAIRFIELD PLUS**  
P. 104

**45314-CO USUB FAIRFIELD**  
P. 16, 104



**45315-CO USUB PERRY PLUS**  
P. 145

**45316-CO USNB COLETTE**  
P. 85

**45404-CO USUB MONROE**  
P. 132

**45405-CO USUB HANSON PLUS**  
P. 110



**45408-CO USUB MELROSE**  
P. 132

**45409-CO USUB HANSON**  
P. 110

**47593-CO USNB CONNOR**  
P. 86

**47635-CO USUB BROCK**  
P. 8, 76

**47642-CO USUB RONNY**  
P. 151



**48593-CO USNB CONNOR**  
P. 86



**48635-CO USUB BROCK**  
P. 76



**48642-CO USUB RONNY**  
P. 151



**49104-CO USMB PAUL**  
P. 142



**49123-CO DSMB CRESCENT**  
P. 88



**49123-CO USMB CRESCENT**  
P. 88



**49198-CO DSMB EDWIN**  
P. 98



**49198-CO USMB EDWIN**  
P. 98



**49224-CO DSDB KYLE**  
P. 123



**49224-CO USDB KYLE**  
P. 123



**49224-CO USWB KYLE**  
P. 123



**49304-CO USUB PABLO**  
P. 140



**49305-CO USUB PABLO PLUS**  
P. 140



**49307-CO USUB BAILEY**  
P. 26, 68



**49308-CO USUB ETHAN**  
P. 103



**49309-CO USUB ETHAN PLUS**  
P. 103



**49575-CO USUB BRIDGET**  
P. 74



**50071-PACO ELIOT**  
P. 200



**50164-CO CRAWFORD**  
P. 184



**50165-CO ELWOOD**  
P. 186



**50264-CO CRAWFORD**  
P. 184



**50265-CO ELWOOD**  
P. 186



**50266-CO MALLOY**  
P. 180



**50364-CO CRAWFORD**  
P. 184



**50365-CO ELWOOD**  
P. 186



**50366-CO MALLOY**  
P. 181



**50464-CO CRAWFORD**  
P. 183



**50465-CO ELWOOD**  
P. 185



**50466-CO MALLOY**  
P. 182



**50500-CO SALTON**  
P. 22, 218



**50500-36/42CO SALTON**  
P. 22, 218



**50507-CO DALIA**  
P. 197



**50507-38/42CO DALIA**  
P. 197



**50536-CO GENESIS**  
P. 201



**50536-36/42CO GENESIS**  
P. 201



**50538-CO MARTINA**  
P. 209



**50547-CO DALIA XL**  
P. 198



**50550-CO JUDY**  
P. 203



**50550-36/42CO JUDY**  
P. 203



**50551-CO BILLY**  
P. 193



**50551-36/42CO BILLY**  
P. 10, 193



**50552-CO LINK**  
P. 207



**50553-CO LINK**  
P. 207



**50554-36/42CO LINK**  
P. 208



**50557-CO BURTON**  
P. 194



**50562-CO SOUTHCROSS**  
P. 220



**50563-CO NORCROSS**  
P. 2, 14, 212



**50563-36/42CO NORCROSS**  
P. 2, 20, 212



**50565-CO PARADE**  
P. 15, 213



**50565-36/42CO PARADE**  
P. 16, 213



**50566-CO PARADE**  
P. 16, 214



**50566-36/42CO PARADE**  
P. 18, 214



**50567-CO SOUTHCROSS**  
P. 220



**50570-CO ALYS**  
P. 4, 191



**50571-CO MORIS**  
P. 210



**50580-CO ALYS**  
P. 191



**50581-CO MORIS**  
P. 210



**50583-PACO LIDYA**  
P. 206



**50601-CO PENELOPE**  
P. 215



**50609-CO KAI**  
P. 10, 204



**50634-CO DIRK**  
P. 199



**50660-CO BENNINGTON**  
P. 26, 192



**50660-36/42CO BENNINGTON**  
P. 192



**50662-CO CARBON**  
P. 25, 26, 196



**50662-36/42CO CARBON**  
P. 25, 196



**50664-CO RICARD**  
P. 216



**50664-36/42CO RICARD**  
P. 216



**50667-CO NICHOLSON**  
P. 19, 211



**50667-36/42CO NICHOLSON**  
P. 19, 211



**50668-CO HARRISON**  
P. 202



**50668-36/42CO HARRISON**  
P. 202



**50696-CO CAMERON**  
P. 195



**50698-CO ROBERT**  
P. 217



**50701/801-CO PENELOPE**  
P. 215



**50709/809-CO KAI**  
P. 204



**50734/834-CO DIRK**  
P. 199



**50764-CO CRAWFORD**  
P. 183



**50765-CO ELWOOD**  
P. 185



**50796/896-CO CAMERON**  
P. 195



**50798/898-CO ROBERT**  
P. 217



**51145-CO RUPERT**  
P. 187



**52553-CO LAREDO**  
P. 205



**52554-CO SIERRA**  
P. 219



**52556-CO SIERRA**  
P. 219



**85500-CO BUNKY BOARD**  
P. 247



**90403-CO**  
P. 222



**90406-CO**  
P. 222



**90407-CO**  
P. 222



**90408-CO**  
P. 222



**90409-CO**  
P. 222



**90412-CO**  
P. 222



**90410-CO**  
P. 222



**90484-CO**  
P. 222



**90485-CO**  
P. 222



**90486-CO**  
P. 222



**90487-CO**  
P. 222



**90491-CO**  
P. 184, 186



**90492-CO**  
P. 184, 186



**90493-CO**  
P. 184, 186



**90494-CO**  
P. 183, 185



**90497-CO**  
P. 183, 185



**90851-CO**  
P. 222



**93406-CO**  
P. 224



**93408-CO**  
P. 224



**93410-CO**  
P. 224



**93412-CO**  
P. 224



**93428-CO**  
P. 224



**93438-CO**  
P. 224



**93485-CO**  
P. 224



**93487-CO**  
P. 224

# Alphabetical Index / *Index alphabétique*

<b>Aaron</b> 40039-CO DSNB ..... P. 57	<b>Burton</b> 50557-CO ..... P. 194	<b>Easton</b> 41535-CO USUB ..... P. 6, 96
<b>Aaron</b> 40039-CO USNB ..... P. 57	<b>Button</b> 42460-CO DSNB ..... P. 80	<b>Edwin</b> 35198-CO DSMB ..... P. 97
<b>Akers</b> 41431-CO USUB ..... P. 58	<b>Button</b> 42460-CO USNB ..... P. 80	<b>Edwin</b> 35198-CO USMB ..... P. 97
<b>Alberto</b> 40112-CO DSMB ..... P. 12, 59	<b>Cameron</b> 50696-CO ..... P. 195	<b>Edwin</b> 41498-CO DSMB ..... P. 98
<b>Alberto</b> 40112-CO USMB ..... P. 59	<b>Cameron</b> 50796/896-CO ..... P. 195	<b>Edwin</b> 41498-CO USMB ..... P. 98
<b>Alto</b> 35309-CO USUB ..... P. 139	<b>Carbon</b> 50662-CO ..... P. 25, 26, 196	<b>Edwin</b> 49198-CO DSMB ..... P. 98
<b>Alys</b> 50570-CO ..... P. 4, 191	<b>Carbon</b> 50662-36/42CO ..... P. 25, 196	<b>Edwin</b> 49198-CO USMB ..... P. 98
<b>Alys</b> 50580-CO ..... P. 191	<b>Cardin</b> 41430-CO USUB ..... P. 81	<b>Eleanor</b> 35210-CO USDB ..... P. 99
<b>Anders</b> 42593-CO USNB ..... P. 60	<b>Century</b> 41549-CO DSMB ..... P. 82	<b>Eleanor</b> 35210-CO USWB ..... P. 99
<b>Angelina</b> 30227-CO DSDB ..... P. 22, 61	<b>Century</b> 41549-CO USMB ..... P. 82	<b>Eleanor</b> 35410-CO USDB ..... P. 99
<b>Angelina</b> 40227-CO DSDB ..... P. 22, 61	<b>Clock</b> 42437-CO USNB ..... P. 83	<b>Eleanor</b> 35410-CO USWB ..... P. 99
<b>Annabelle</b> 35219-CO DSDB ..... P. 62	<b>Club</b> 39667-CO DSMB ..... P. 84	<b>Eleanor</b> 41410-CO USDB ..... P. 100
<b>Annabelle</b> 35219-CO USDB ..... P. 62	<b>Club</b> 39667-CO USMB ..... P. 84	<b>Eleanor</b> 41410-CO USWB ..... P. 100
<b>Annabelle</b> 35219-CO USWB ..... P. 62	<b>Club</b> 41667-CO DSMB ..... P. 84	<b>Elegance</b> 13507-PMCO ..... P. 235
<b>Annabelle</b> 35419-CO USDB ..... P. 63	<b>Club</b> 41667-CO USMB ..... P. 84	<b>Eliot</b> 50071-PACO ..... P. 200
<b>Annabelle</b> 35419-CO USWB ..... P. 63	<b>Colette</b> 35316-CO USUB ..... P. 85	<b>Eller</b> 44542-CO USUB ..... P. 101
<b>Annabelle</b> 41419-CO DSDB ..... P. 64	<b>Colette</b> 45316-CO USUB ..... P. 85	<b>Elmira</b> 30530-CO USUB ..... P. 102
<b>Annabelle</b> 41419-CO USDB ..... P. 64	<b>Connor</b> 42493-CO DSNB ..... P. 86	<b>Elmira</b> 41530-CO USUB ..... P. 102
<b>Annabelle</b> 41419-CO USWB ..... P. 64	<b>Connor</b> 42493-CO USNB ..... P. 86	<b>Elwood</b> 50165-CO ..... P. 186
<b>Architect</b> 30263-CO DSDB ..... P. 15, 65	<b>Connor</b> 47593-CO USNB ..... P. 86	<b>Elwood</b> 50265-CO ..... P. 186
<b>Architect</b> 30263-CO USDB ..... P. 65	<b>Connor</b> 48593-CO USNB ..... P. 86	<b>Elwood</b> 50365-CO ..... P. 186
<b>Architect</b> 30563-CO DSMB ..... P. 65	<b>Corey</b> 34560-CO USUB ..... P. 26, 87	<b>Elwood</b> 50465-CO ..... P. 185
<b>Architect</b> 30563-CO USMB ..... P. 65	<b>Corey</b> 44560-CO USUB ..... P. 87	<b>Elwood</b> 50765-CO ..... P. 185
<b>Architect</b> 40263-CO DSDB ..... P. 14, 66	<b>Crawford</b> 50164-CO ..... P. 184	<b>Ethan</b> 49308-CO USUB ..... P. 103
<b>Architect</b> 40263-CO USDB ..... P. 66	<b>Crawford</b> 50264-CO ..... P. 184	<b>Ethan Plus</b> 49309-CO USUB ..... P. 103
<b>Architect</b> 40563-CO DSMB ..... P. 66	<b>Crawford</b> 50364-CO ..... P. 184	<b>Fairfield Plus</b> 45313-CO USUB ..... P. 104
<b>Architect</b> 40563-CO USMB ..... P. 66	<b>Crawford</b> 50464-CO ..... P. 183	<b>Fairfield</b> 45314-CO USUB ..... P. 16, 104
<b>Architect</b> 42563-CO DSNB ..... P. 67	<b>Crawford</b> 50764-CO ..... P. 183	<b>Garden</b> 41488-CO USMB ..... P. 105
<b>Architect</b> 42563-CO USNB ..... P. 67	<b>Crescent</b> 39123-CO DSMB ..... P. 88	<b>Gastown</b> 13511-PMCO ..... P. 236
<b>Bailey</b> 49307-CO USUB ..... P. 26, 68	<b>Crescent</b> 39123-CO USMB ..... P. 88	<b>Gatlin</b> 40491-CO DSMB ..... P. 106
<b>Barry</b> 41445-CO USUB ..... P. 69	<b>Crescent</b> 49123-CO DSMB ..... P. 88	<b>Gatlin</b> 40491-CO USMB ..... P. 106
<b>Bean</b> 39268-CO DSDB ..... P. 70	<b>Crescent</b> 49123-CO USMB ..... P. 88	<b>Genesis</b> 50536-CO ..... P. 201
<b>Bean</b> 39268-CO USDB ..... P. 70	<b>Crocus</b> 13503-PMCO ..... P. 234	<b>Genesis</b> 50536-36/42CO ..... P. 201
<b>Bean</b> 39568-CO DSMB ..... P. 70	<b>Cynthia</b> 35211-CO USDB ..... P. 89	<b>Grace</b> 42414-CO DSNB ..... P. 107
<b>Bean</b> 39568-CO USMB ..... P. 70	<b>Cynthia</b> 35411-CO USDB ..... P. 89	<b>Grace</b> 42414-CO USNB ..... P. 107
<b>Bean</b> 41268-CO DSDB ..... P. 71	<b>Cynthia</b> 41411-CO USDB ..... P. 89	<b>Granville</b> 13510-PMCO ..... P. 237
<b>Bean</b> 41268-CO USDB ..... P. 71	<b>Cynthia</b> 35211-CO USWB ..... P. 90	<b>Grissom</b> 30560-CO USUB ..... P. 18, 108
<b>Bean</b> 41568-CO DSMB ..... P. 71	<b>Cynthia</b> 35411-CO USWB ..... P. 90	<b>Grissom Plus</b> 30561-CO USUB ..... P. 108
<b>Bean</b> 41568-CO USMB ..... P. 71	<b>Cynthia</b> 41411-CO USWB ..... P. 90	<b>Grissom</b> 41560-CO USUB ..... P. 18, 108
<b>Bennington</b> 50660-CO ..... P. 26, 192	<b>Dalia</b> 50507-CO ..... P. 197	<b>Gustavson</b> 44661-CO DSDB ..... P. 109
<b>Bennington</b> 50660-36/42CO ..... P. 192	<b>Dalia</b> 50507-38/42CO ..... P. 197	<b>Gustavson</b> 44661-CO USDB ..... P. 109
<b>Billy</b> 50551-CO ..... P. 193	<b>Dalia XL</b> 50547-CO ..... P. 198	<b>Hanson Plus</b> 45405-CO USUB ..... P. 110
<b>Billy</b> 50551-36/42CO ..... P. 10, 193	<b>Darcy</b> 30574-CO USUB ..... P. 24, 91	<b>Hanson</b> 45409-CO USUB ..... P. 110
<b>Bounty</b> 13523-PMCO ..... P. 232	<b>Darcy</b> 40574-CO USUB ..... P. 91	<b>Harrison</b> 50668-CO ..... P. 202
<b>Bourbon</b> 41522-CO USWB ..... P. 72	<b>Darlene</b> 30573-CO USUB ..... P. 92	<b>Harrison</b> 50668-36/42CO ..... P. 202
<b>Bradley</b> 40038-CO DSNB ..... P. 73	<b>Darlene</b> 40573-CO USUB ..... P. 24, 92	<b>Hartman</b> 44573-CO USUB ..... P. 111
<b>Bradley</b> 40038-CO USNB ..... P. 73	<b>Derek</b> 41443-CO USMB ..... P. 93	<b>Hint</b> 39202-CO USWB ..... P. 112
<b>Breeze</b> 13504-PMCO ..... P. 233	<b>Dexter</b> 30223-CO DSDB ..... P. 2, 94	<b>Hint</b> 40202-CO USWB ..... P. 112
<b>Breeze</b> 13504-PMCO ..... P. 233	<b>Dexter</b> 30223-CO USDB ..... P. 94	<b>Historian</b> 41402-CO USWB ..... P. 113
<b>Bridget</b> 30575-CO USUB ..... P. 22, 74	<b>Dexter</b> 40323-CO DSDB ..... P. 2, 94	<b>Jacob</b> 34572-CO USUB ..... P. 114
<b>Bridget</b> 49575-CO USUB ..... P. 74	<b>Dexter</b> 40323-CO USDB ..... P. 94	<b>Jacob</b> 44572-CO USUB ..... P. 114
<b>Brixton</b> 30536-CO USUB ..... P. 75	<b>Dirk</b> 50634-CO ..... P. 199	<b>Jetson</b> 41527-CO DSMB ..... P. 115
<b>Brixton</b> 41536-CO USUB ..... P. 75	<b>Dirk</b> 50734/834-CO ..... P. 199	<b>Jetson</b> 41527-CO USMB ..... P. 115
<b>Brock</b> 47635-CO USUB ..... P. 8, 76	<b>Dryden</b> 30409-CO DSNB ..... P. 179	<b>Jetson</b> 41567-CO DSDB ..... P. 116
<b>Brock</b> 48635-CO USUB ..... P. 76	<b>Dryden</b> 30409-CO USNB ..... P. 179	<b>Jetson</b> 41567-CO USDB ..... P. 116
<b>Brockton</b> 41585-CO ..... P. 77	<b>Dryden</b> 30419-CO DSNB ..... P. 179	<b>Joan</b> 30237-CO USUB ..... P. 117, 188
<b>Browser</b> 41542-CO USUB ..... P. 78	<b>Dryden</b> 30419-CO USNB ..... P. 179	<b>Jonas</b> 30137-CO USUB ..... P. 117
<b>Bryce</b> 41444-CO USNB ..... P. 79	<b>Duncan</b> 41540-CO USUB ..... P. 95	<b>Jonas</b> 41437-CO USUB ..... P. 117
<b>Bunky Board</b> 85500-CO ..... P. 247	<b>Easton</b> 30535-CO USUB ..... P. 6, 96	<b>Judy</b> 50550-CO ..... P. 203



<b>Judy</b> 50550-36/42CO.....	P. 203	<b>Norcross</b> 50563-CO.....	P. 2, 14, 212	<b>Scroller</b> 41624-CO USMB.....	P. 155
<b>Kai</b> 50609-CO.....	P. 10, 204	<b>Norcross</b> 50563-36/42CO .	P. 2, 20, 212	<b>Sierra</b> 52554-CO.....	P. 219
<b>Kai</b> 50709/809-CO.....	P. 204	<b>Nox</b> 42534-CO USNB.....	P. 135	<b>Sierra</b> 52556-CO.....	P. 219
<b>Kent</b> 41528-CO DSMB.....	P. 118	<b>Opus</b> 39132-CO USUB.....	P. 136	<b>Sinclair</b> 44501-CO USNB.....	P. 156
<b>Kent</b> 41528-CO USMB.....	P. 118	<b>Opus</b> 40132-CO USUB.....	P. 136	<b>Singapore</b> 30435-CO USUB.....	P. 8, 18, 190
<b>Kris</b> 40494-CO USUB.....	P. 119	<b>Owen</b> 39154-CO DSMB.....	P. 137	<b>Snyder</b> 30529-CO DSDB.....	P. 157
<b>Kyle</b> 35214-CO DSDB.....	P. 120	<b>Owen</b> 39154-CO USMB.....	P. 137	<b>Snyder</b> 30529-CO USDB.....	P. 157
<b>Kyle</b> 35214-CO USDB.....	P. 120	<b>Owen</b> 41454-CO USMB.....	P. 137	<b>Snyder</b> 41529-CO-DSDB.....	P. 157
<b>Kyle</b> 35214-CO USWB.....	P. 120	<b>Oxford</b> 41510-CO USUB.....	P. 138	<b>Snyder</b> 41529-CO USDB.....	P. 157
<b>Kyle</b> 35414-CO USDB.....	P. 121	<b>Pablo</b> 30472-CO USUB.....	P. 177	<b>Southcross</b> 50562-CO.....	P. 220
<b>Kyle</b> 35414-CO USWB.....	P. 121	<b>Pablo</b> 30473-CO USUB.....	P. 177	<b>Southcross</b> 50567-CO.....	P. 220
<b>Kyle</b> 41414-CO DSDB.....	P. 122	<b>Pablo</b> 35304-CO USUB.....	P. 11, 26, 139	<b>Staten</b> 41474-CO USUB.....	P. 158
<b>Kyle</b> 41414-CO USDB.....	P. 122	<b>Pablo</b> 40372-CO USUB.....	P. 177	<b>Stinson</b> 41545-CO USUB.....	P. 159
<b>Kyle</b> 41414-CO USWB.....	P. 122	<b>Pablo</b> 49304-CO USUB.....	P. 140	<b>Swan</b> 42496-CO USNB.....	P. 160
<b>Kyle</b> 49224-CO DSDB.....	P. 123	<b>Pablo Plus</b> 49305-CO USUB.....	P. 140	<b>Swice</b> 42444-CO DSNB.....	P. 161
<b>Kyle</b> 49224-CO USDB.....	P. 123	<b>Pacey</b> 35319-CO USUB.....	P. 144	<b>Swice</b> 42444-CO USNB.....	P. 161
<b>Kyle</b> 49224-CO USWB.....	P. 123	<b>Parade</b> 50565-CO.....	P. 15, 213	<b>Symmetry</b> 31669-CO DSDB.....	P. 162
<b>Laredo</b> 52553-CO.....	P. 205	<b>Parade</b> 50565-36/42CO.....	P. 16, 213	<b>Symmetry</b> 31669-CO USDB.....	P. 162
<b>Larkin</b> 44570-CO USMB.....	P. 124	<b>Parade</b> 50566-CO.....	P. 16, 214	<b>Symmetry</b> 41669-CO DSDB.....	P. 162
<b>Larry</b> 35313-CO USUB.....	P. 144	<b>Parade</b> 50566-36/42CO.....	P. 18, 214	<b>Symmetry</b> 41669-CO USDB.....	P. 162
<b>Lauren</b> 30593-CO DSMB.....	P. 125	<b>Parker</b> 44412-CO USUB.....	P. 141	<b>Tori</b> 39124-CO DSMB.....	P. 163
<b>Lauren</b> 30593-CO USMB.....	P. 125	<b>Paul</b> 49104-CO USMB.....	P. 142	<b>Tori</b> 39124-CO USMB.....	P. 163
<b>Lauren</b> 40593-CO DSMB.....	P. 125	<b>Payton</b> 30103-CO USUB.....	P. 143	<b>Tori</b> 39144-CO DSMB.....	P. 163
<b>Lauren</b> 40593-CO USMB.....	P. 125	<b>Payton</b> 40103-CO USUB.....	P. 143	<b>Tori</b> 39144-CO USMB.....	P. 163
<b>Legend</b> 13501-PMCO.....	P. 230, 238	<b>Pedro</b> 35308-CO USUB.....	P. 139	<b>Tower</b> 41475-CO USUB.....	P. 164
<b>Leo</b> 35305-CO USUB.....	P. 139	<b>Penelope</b> 50601-CO.....	P. 215	<b>Travis</b> 44443-CO USUB.....	P. 165
<b>Lidya</b> 50583-PACO.....	P. 206	<b>Penelope</b> 50701/801-CO.....	P. 215	<b>Turbo</b> 41493-CO DSMB.....	P. 166
<b>Link</b> 50552-CO.....	P. 207	<b>Penny</b> 35318-CO USUB.....	P. 144	<b>Turbo</b> 41493-CO USMB.....	P. 166
<b>Link</b> 50553-CO.....	P. 207	<b>Perry</b> 35312-CO USUB.....	P. 16, 144	<b>Unity</b> 41663-CO DSDB.....	P. 167
<b>Link</b> 50554-36/42CO.....	P. 208	<b>Perry</b> 45312-CO USUB.....	P. 145	<b>Unity</b> 41663-CO USDB.....	P. 167
<b>Madison</b> 41406-CO USWB.....	P. 126	<b>Perry Plus</b> 45315-CO USUB.....	P. 145	<b>Unity</b> 41666-CO DSMB.....	P. 167
<b>Malloy</b> 50266-CO.....	P. 180	<b>Phylo</b> 42402-CO USNB.....	P. 146	<b>Unity</b> 41666-CO USMB.....	P. 167
<b>Malloy</b> 50366-CO.....	P. 181	<b>Radcliff</b> 41537-CO USUB.....	P. 147	<b>Uplift</b> 40614-CO DSMB.....	P. 168
<b>Malloy</b> 50466-CO.....	P. 182	<b>Radcliff</b> 41557-CO USUB.....	P. 147	<b>Uplift</b> 40614-CO USMB.....	P. 168
<b>Marcus</b> 39151-CO USMB.....	P. 127	<b>Rally</b> 31661-CO DSDB.....	P. 148	<b>Uplift</b> 42614-CO DSNB.....	P. 168
<b>Marcus</b> 41451-CO USMB.....	P. 127	<b>Rally</b> 31661-CO USDB.....	P. 148	<b>Uplift</b> 42614-CO USNB.....	P. 168
<b>Marlon</b> 35409-CO USUB.....	P. 131	<b>Rally</b> 40661-CO DSDB.....	P. 148	<b>Upright</b> 30408-CO DSNB.....	P. 178
<b>Martina</b> 50538-CO.....	P. 209	<b>Rally</b> 40661-CO USDB.....	P. 148	<b>Upright</b> 30408-CO USNB.....	P. 178
<b>Meadow</b> 41466-CO USMB.....	P. 128	<b>Regent</b> 30576-CO USUB.....	P. 149	<b>Upright</b> 30410-CO DSNB.....	P. 15, 178
<b>Melrose</b> 35408-CO USUB.....	P. 131	<b>Regent</b> 41576-CO USUB.....	P. 149	<b>Upright</b> 30410-CO USNB.....	P. 178
<b>Melrose</b> 45408-CO USUB.....	P. 132	<b>Regent</b> 41586-CO USUB.....	P. 149	<b>Upright</b> 40264-CO DSDB.....	P. 169
<b>Miller</b> 40035-CO USNB.....	P. 129	<b>Render</b> 41543-CO DSMB.....	P. 150	<b>Upright</b> 40264-CO USDB.....	P. 20, 169
<b>Minto</b> 41548-CO USUB.....	P. 130	<b>Render</b> 41543-CO USMB.....	P. 150	<b>Upright</b> 42564-CO DSNB.....	P. 169
<b>Mitchell</b> 35405-CO USUB.....	P. 131	<b>Ricard</b> 50664-CO.....	P. 216	<b>Upright</b> 42564-CO USNB.....	P. 169
<b>Monroe</b> 30474-CO USUB.....	P. 176	<b>Ricard</b> 50664-36/42CO.....	P. 216	<b>Uptown</b> 12340-39CO.....	P. 245
<b>Monroe</b> 30478-CO USUB.....	P. 176	<b>Robert</b> 50698-CO.....	P. 217	<b>Uptown</b> 12340-VBCO..	P. 242, 243, 244
<b>Monroe</b> 35404-CO USUB.....	P. 131	<b>Robert</b> 50798/898-CO.....	P. 217	<b>Washington</b> 30303-CO USMB.....	P. 10, 170
<b>Monroe</b> 45404-CO USUB.....	P. 132	<b>Ronny</b> 41442-CO USUB.....	P. 151	<b>Washington</b> 40303-CO USMB...	P. 10, 170
<b>Moris</b> 50571-CO.....	P. 210	<b>Ronny</b> 47642-CO USUB.....	P. 151	<b>Webber</b> 30330-CO USUB.....	P. 171
<b>Moris</b> 50581-CO.....	P. 210	<b>Ronny</b> 48642-CO USUB.....	P. 151	<b>Webber</b> 41330-CO USUB.....	P. 171
<b>Munich</b> 30425-CO USUB.....	P. 189	<b>Rudy</b> 42442-CO USNB.....	P. 152	<b>Wellington</b> 41516-CO USMB.....	P. 172
<b>Muro</b> 13509-PMCO.....	P. 239	<b>Rupert</b> 21145-CO.....	P. 187	<b>Wembley</b> 41578-CO USUB.....	P. 173
<b>Namaste</b> 13508-PMCO.....	P. 240	<b>Rupert</b> 51145-CO.....	P. 187	<b>Weston</b> 30534-CO USUB.....	P. 4, 174
<b>Nanaimo</b> 13518-PMCO.....	P. 241, 242	<b>Russell</b> 41526-CO USUB.....	P. 153	<b>Weston</b> 41534-CO USUB.....	P. 4, 174
<b>Nathan</b> 40033-CO USNB.....	P. 133	<b>Ryan</b> 40034-CO DSNB.....	P. 154	<b>Wilbur</b> 39570-CO USUB.....	P. 175
<b>Nest</b> 41477-CO DSMB.....	P. 134	<b>Ryan</b> 40034-CO USNB.....	P. 154	<b>Wilbur</b> 41570-CO USUB.....	P. 175
<b>Nest</b> 41477-CO USMB.....	P. 134	<b>Salton</b> 50500-CO.....	P. 22, 218		
<b>Nicholson</b> 50667-CO.....	P. 19, 211	<b>Salton</b> 50500-36/42CO.....	P. 22, 218		
<b>Nicholson</b> 50667-36/42CO.....	P. 19, 211	<b>Scroller</b> 41624-CO DSMB.....	P. 155		



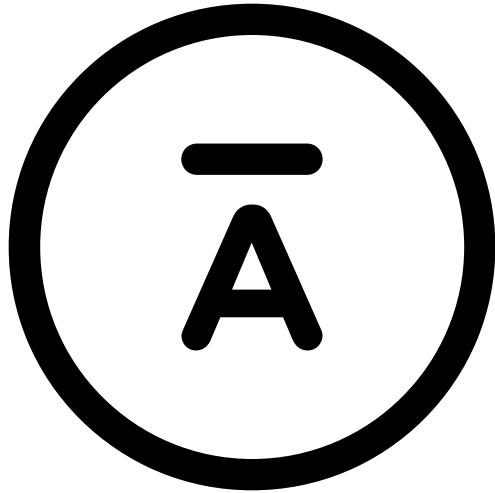



**AMISCO**

**CONTRACT FURNITURE**  
**MOBILIER COMMERCIAL**

**AMISCO INDUSTRIES LTD.**  
**LES INDUSTRIES AMISCO LTÉE**

33, 5<sup>e</sup> Rue, L'Islet, Québec G0R 2C0 CANADA

T 418 247-5025 / 1 800 361-6360

F 418 247-7896 / 1 800 232-6614

[www.amiscocontract.com](http://www.amiscocontract.com)

**Eco Amisco**

Please recycle this catalogue  
S.V.P. Recyclez ce catalogue

PRINTED IN CANADA  
IMPRIMÉ AU CANADA





**CONTRACT FURNITURE | MOBILIER COMMERCIAL**

Collection 2019/2020